

Kontroll-
quadrat
5x5 cm

7a

sewing epiphanies

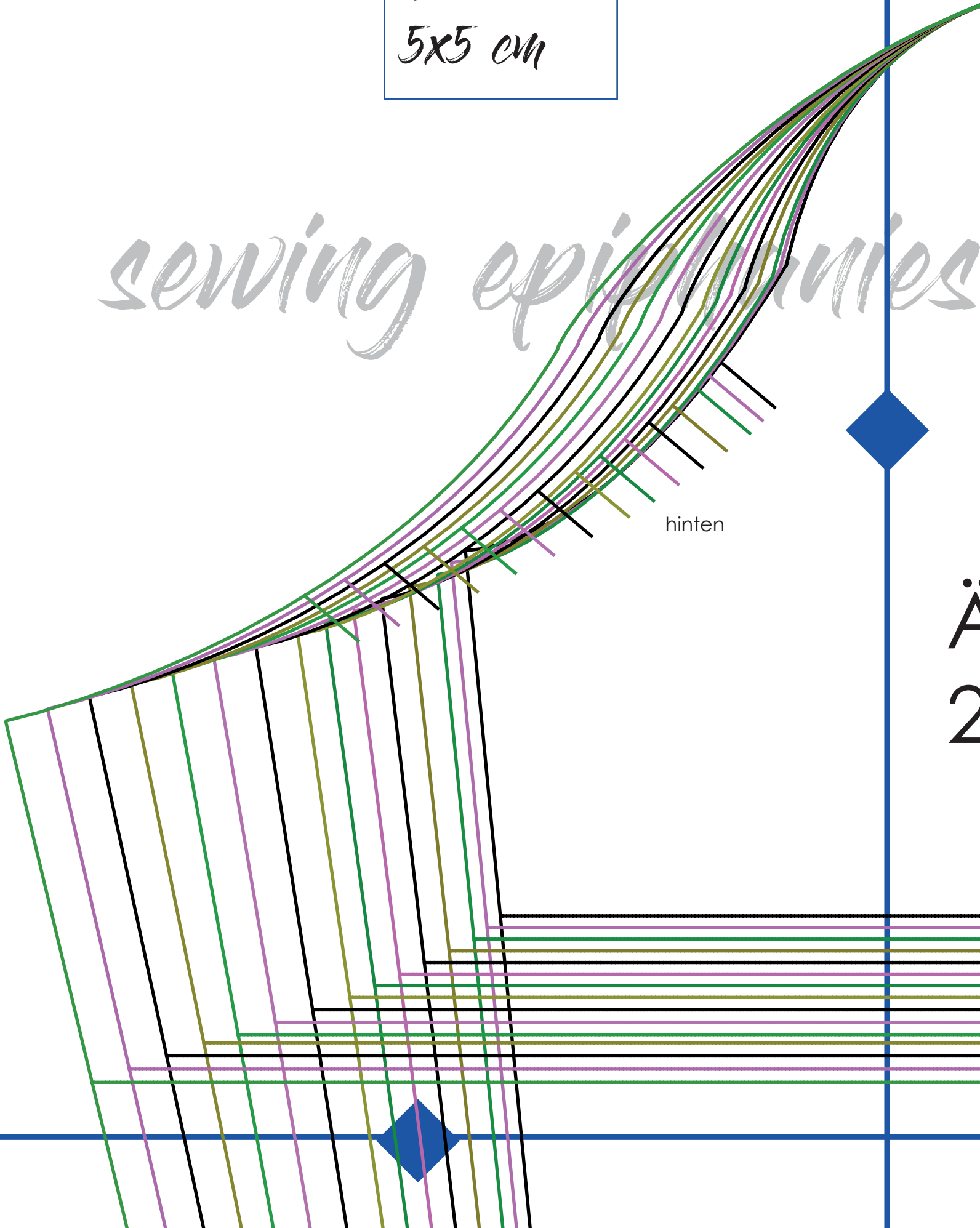

Ä
2

2a

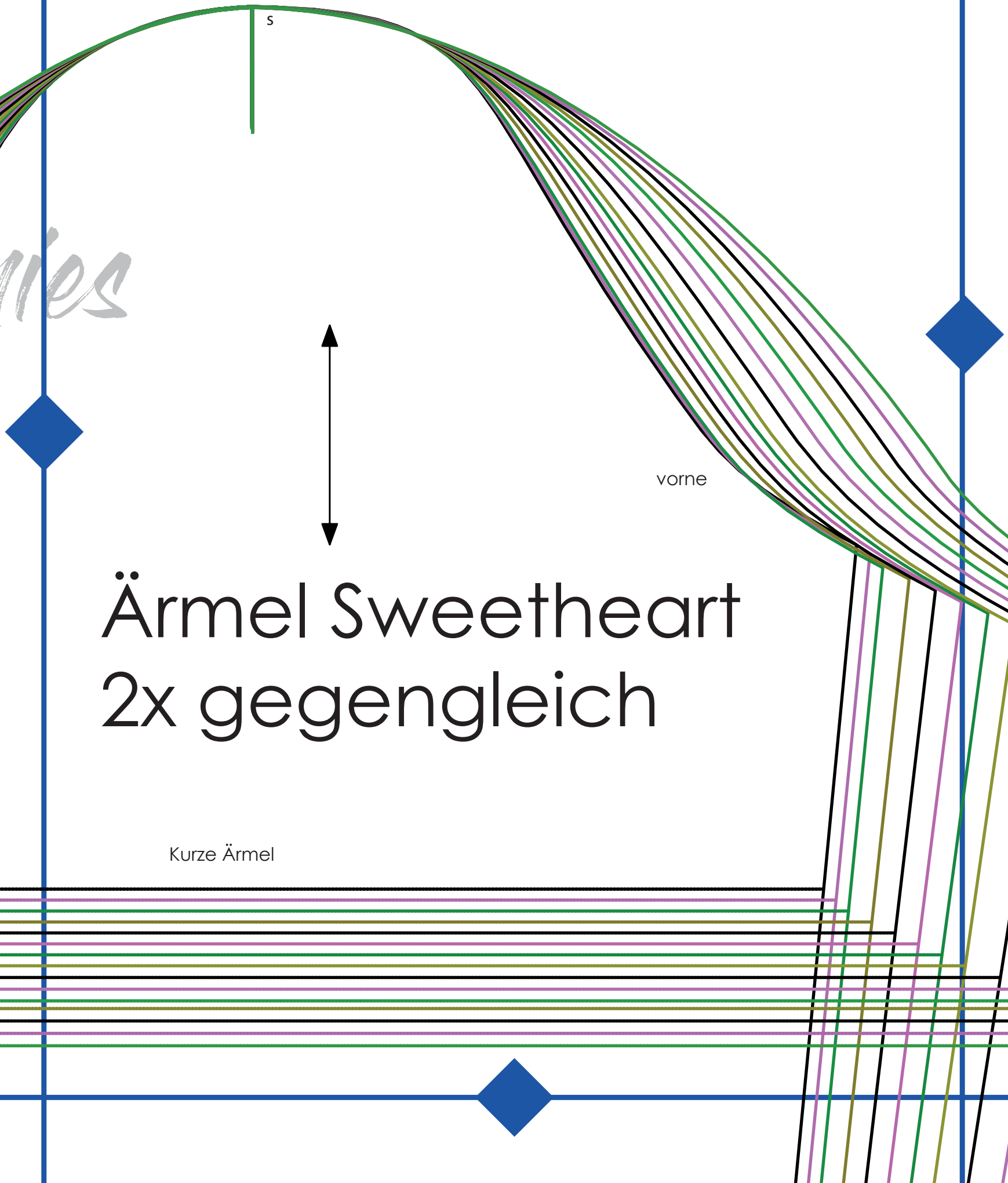

ries

vorne

Ärmel Sweetheart 2x gegengleich

Kurze Ärmel

3a

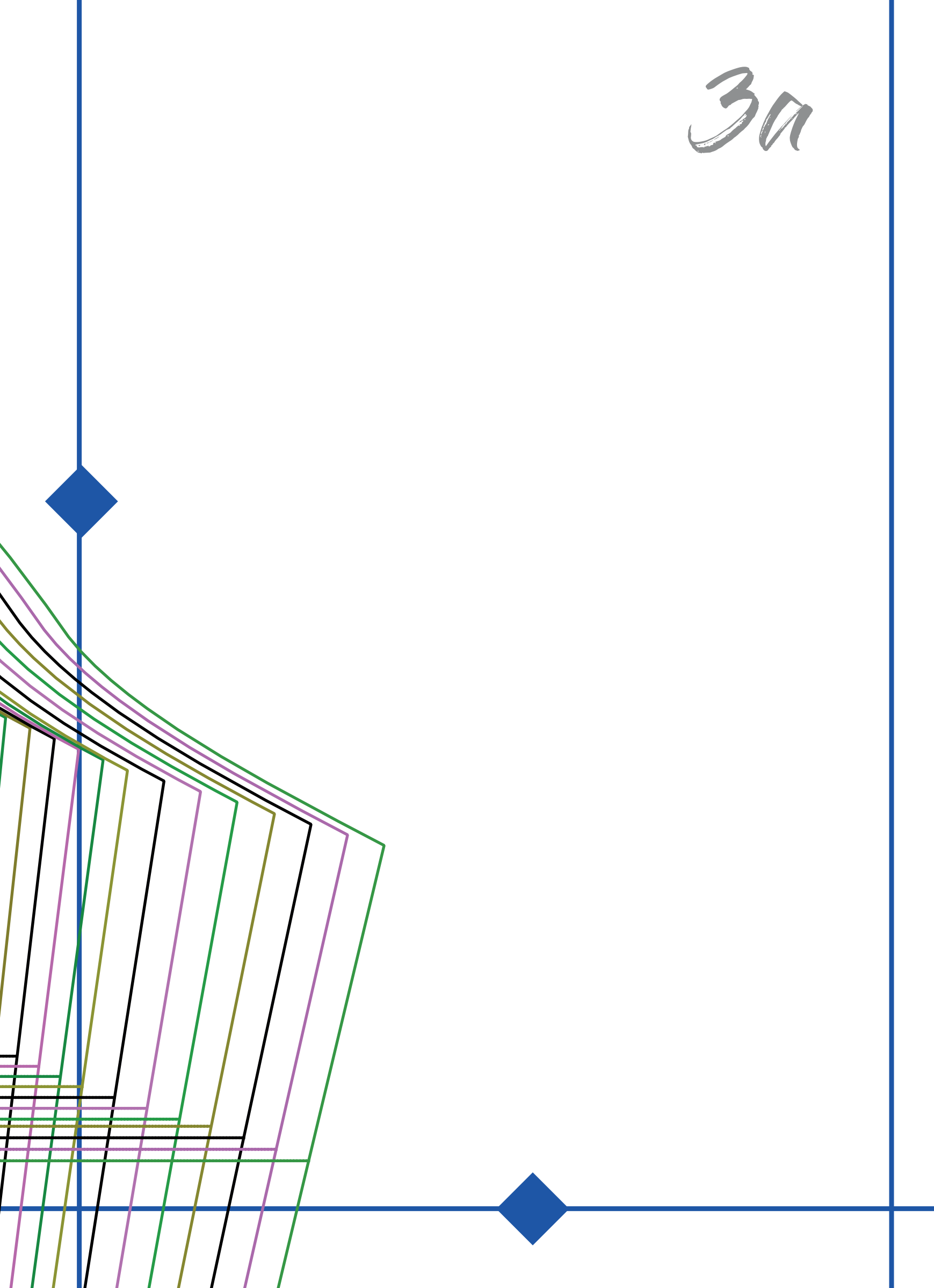

46

servina

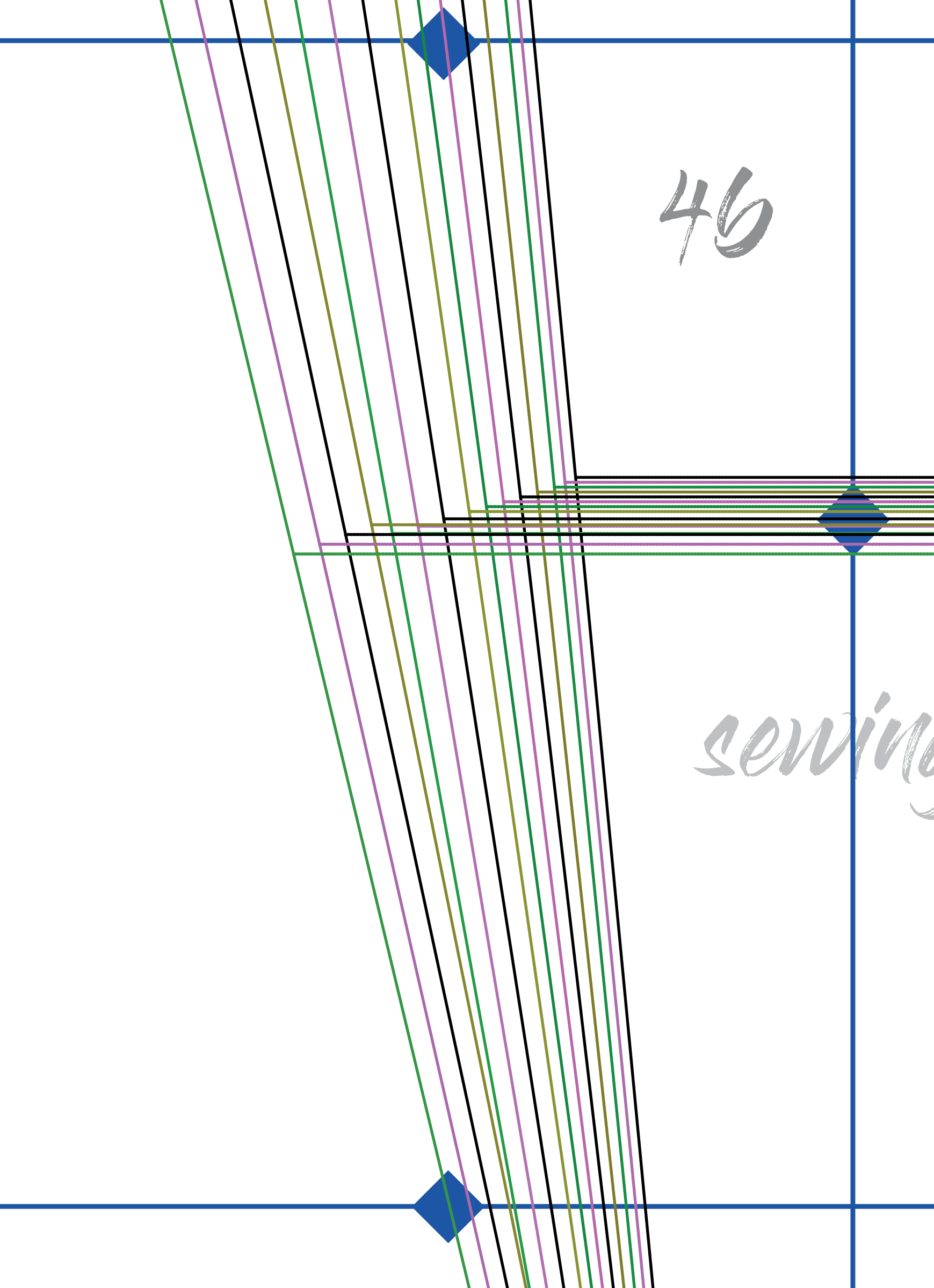

56

Halblange Ärmel

ving epiphanies

66

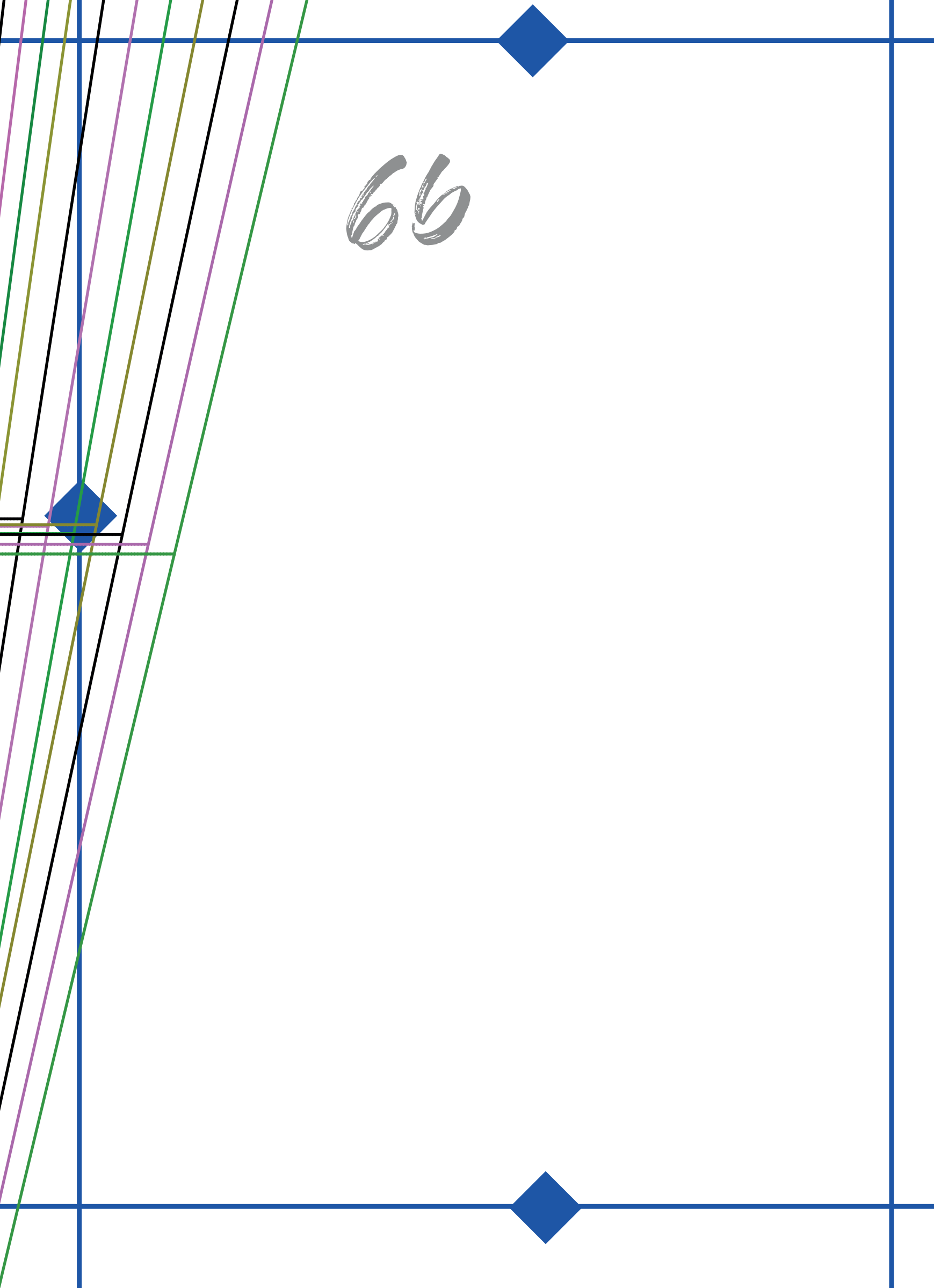

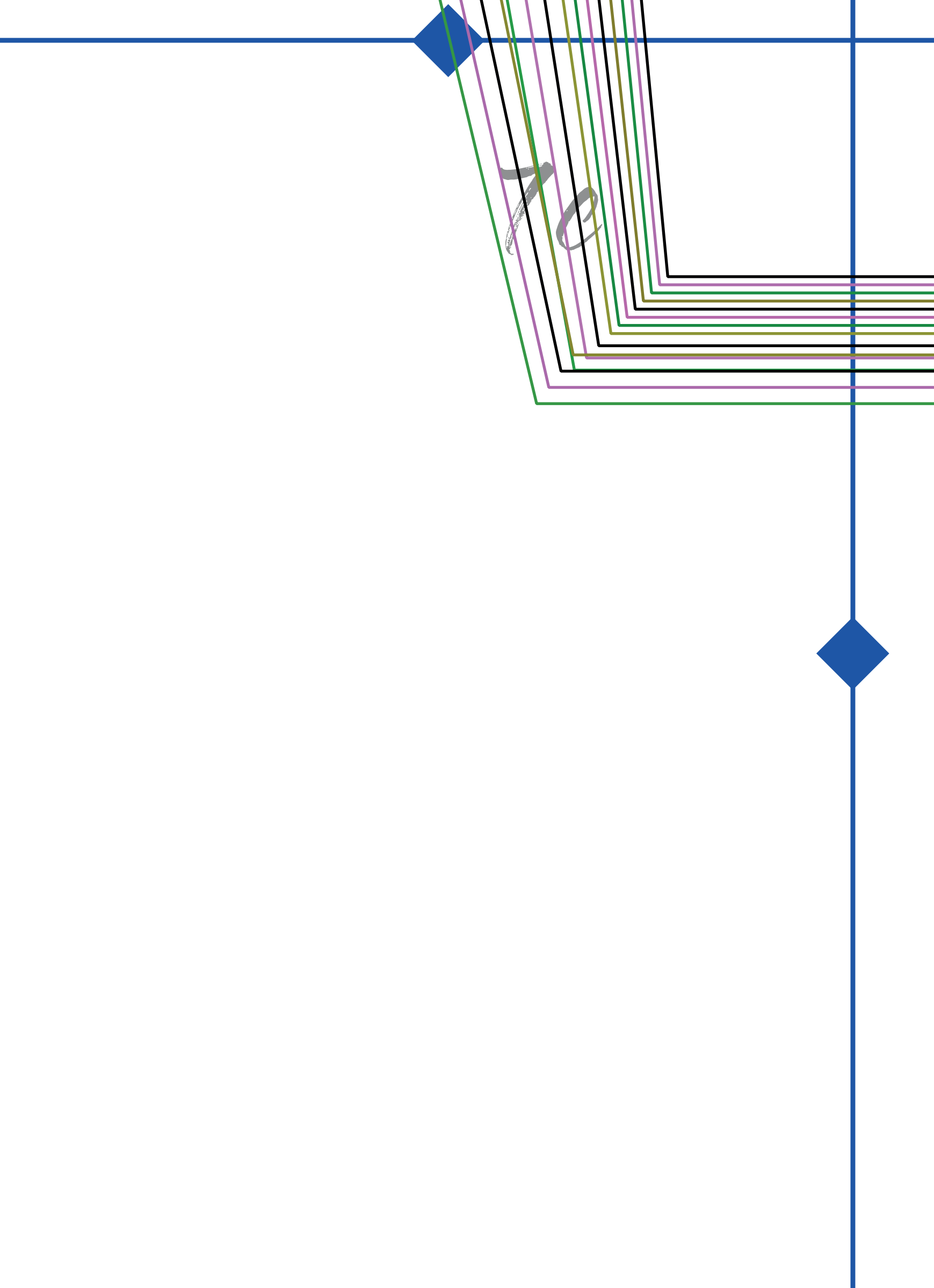

Langarm

80

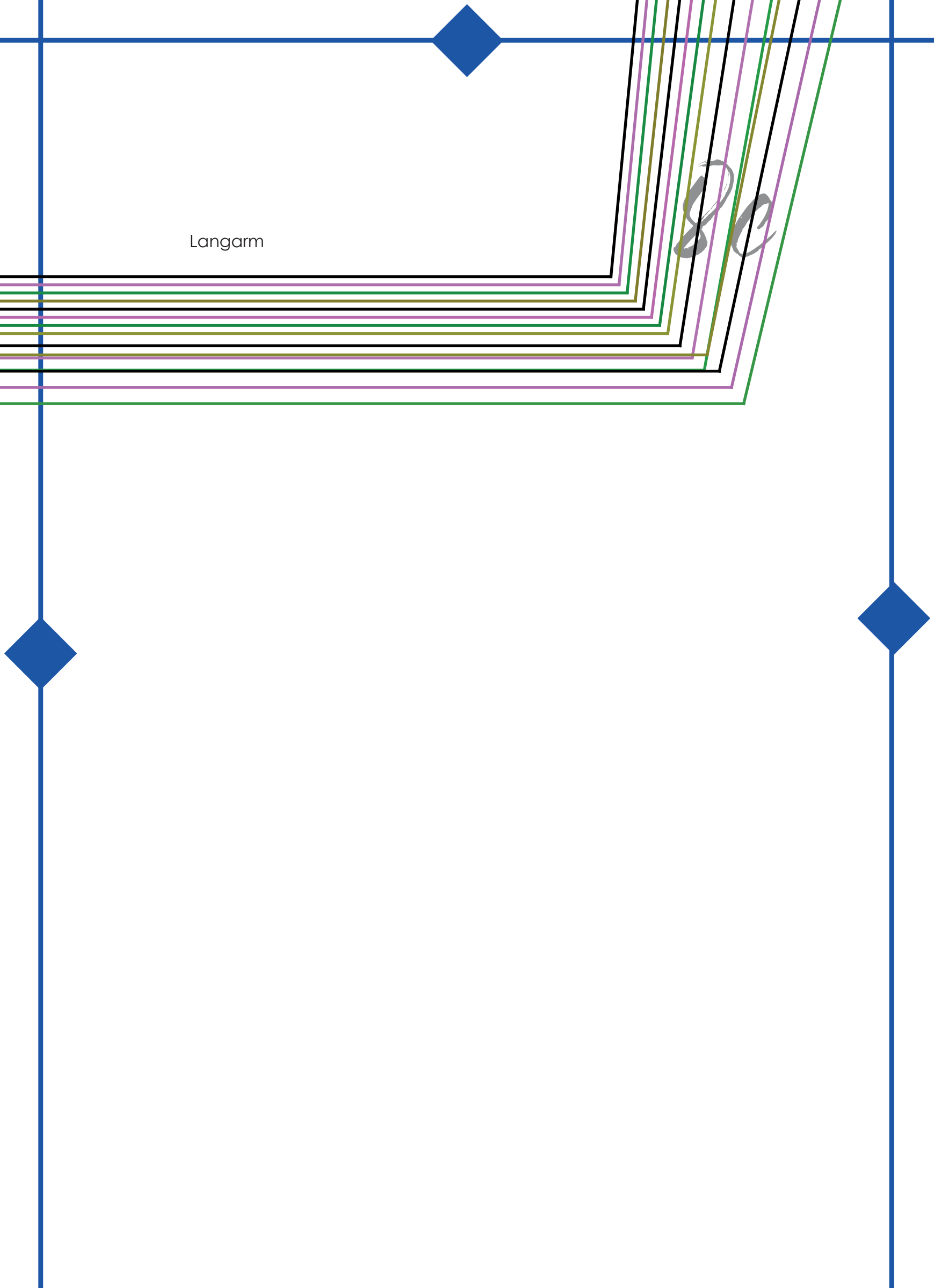

9c