



*970 Pro3 R2.0*

# User Manual

Version 1.1

Published June 2013

Copyright©2013 ASRock INC. All rights reserved.

---

## Copyright Notice:

No part of this manual may be reproduced, transcribed, transmitted, or translated in any language, in any form or by any means, except duplication of documentation by the purchaser for backup purpose, without written consent of ASRock Inc.

Products and corporate names appearing in this manual may or may not be registered trademarks or copyrights of their respective companies, and are used only for identification or explanation and to the owners' benefit, without intent to infringe.

## Disclaimer:

Specifications and information contained in this manual are furnished for informational use only and subject to change without notice, and should not be constructed as a commitment by ASRock. ASRock assumes no responsibility for any errors or omissions that may appear in this manual.

With respect to the contents of this manual, ASRock does not provide warranty of any kind, either expressed or implied, including but not limited to the implied warranties or conditions of merchantability or fitness for a particular purpose.

In no event shall ASRock, its directors, officers, employees, or agents be liable for any indirect, special, incidental, or consequential damages (including damages for loss of profits, loss of business, loss of data, interruption of business and the like), even if ASRock has been advised of the possibility of such damages arising from any defect or error in the manual or product.



This device complies with Part 15 of the FCC Rules. Operation is subject to the following two conditions:

- (1) this device may not cause harmful interference, and
- (2) this device must accept any interference received, including interference that may cause undesired operation.

## CALIFORNIA, USA ONLY

The Lithium battery adopted on this motherboard contains Perchlorate, a toxic substance controlled in Perchlorate Best Management Practices (BMP) regulations passed by the California Legislature. When you discard the Lithium battery in California, USA, please follow the related regulations in advance.

“Perchlorate Material-special handling may apply, see

[www.dtsc.ca.gov/hazardouswaste/perchlorate](http://www.dtsc.ca.gov/hazardouswaste/perchlorate)”

**ASRock Website:** <http://www.asrock.com>

---

# Contents

<b>1. Introduction .....</b>	<b>5</b>
1.1 Package Contents .....	5
1.2 Specifications.....	6
1.3 Unique Features .....	10
1.4 Motherboard Layout .....	15
1.5 I/O Panel .....	16
<b>2. Installation .....</b>	<b>17</b>
Pre-installation Precautions .....	17
2.1 CPU Installation .....	18
2.2 Installation of CPU Fan and Heatsink .....	18
2.3 Installation of Memory Modules (DIMM).....	19
2.4 Expansion Slots (PCI and PCI Express Slots).....	21
2.5 CrossFireX™ and Quad CrossFireX™ Operation Guide.....	22
2.6 Surround Display Information .....	25
2.7 ASRock Smart Remote Installation Guide.....	26
2.8 Jumpers Setup.....	28
2.9 Onboard Headers and Connectors .....	29
2.10 Serial ATA3 (SATA3) Hard Disks Installation .....	34
2.11 Hot Plug and Hot Swap Functions for SATA3 HDDs .....	34
2.12 SATA3 HDD Hot Plug Feature and Operation Operation Guide	35
2.13 Driver Installation Guide .....	37
2.14 Installing Windows® 8 / 8 64-bit / 7 / 7 64-bit / Vista™ / Vista™ 64-bit / XP / XP 64-bit With RAID Functions .....	37
2.14.1 Installing Windows® XP / XP 64-bit With RAID Functions .....	37
2.14.2 Installing Windows® 8 / 8 64-bit / 7 / 7 64-bit / Vista™ / Vista™ 64-bit With RAID Functions.....	38
2.15 Installing Windows® 8 / 8 64-bit / 7 / 7 64-bit / Vista™ / Vista™ 64-bit / XP / XP 64-bit Without RAID Functions .....	39
2.15.1 Installing Windows® XP / XP 64-bit Without RAID Functions .....	39
2.15.2 Installing Windows® 8 / 8 64-bit / 7 / 7 64-bit / Vista™ / Vista™ 64-bit Without RAID Functions.....	40
2.16 Untied Overclocking Technology .....	40

---

<b>3. UEFI SETUP UTILITY.....</b>	<b>41</b>
3.1 Introduction .....	41
3.1.1 UEFI Menu Bar .....	41
3.1.2 Navigation Keys.....	42
3.2 Main Screen.....	43
3.3 OC Tweaker Screen.....	44
3.4 Advanced Screen .....	48
3.4.1 CPU Configuration.....	49
3.4.2 North Bridge Configuration .....	50
3.4.3 South Bridge Configuration .....	51
3.4.4 Storage Configuration.....	52
3.4.5 Super IO Configuration.....	53
3.4.6 ACPI Configuration.....	54
3.4.7 USB Configuration .....	56
3.4.8 Network Configuration .....	57
3.5 Hardware Health Event Monitoring Screen .....	58
3.6 Boot Screen .....	59
3.7 Security Screen .....	61
3.8 Exit Screen .....	62
<b>4. Software Support .....</b>	<b>63</b>
4.1 Install Operating System.....	63
4.2 Support CD Information .....	63
4.2.1 Running Support CD .....	63
4.2.2 Drivers Menu .....	63
4.2.3 Utilities Menu .....	63
4.2.4 Contact Information .....	63

---

# 1. Introduction

Thank you for purchasing ASRock **970 Pro3 R2.0** motherboard, a reliable motherboard produced under ASRock's consistently stringent quality control. It delivers excellent performance with robust design conforming to ASRock's commitment to quality and endurance.

In this manual, chapter 1 and 2 contain introduction of the motherboard and step-by-step guide to the hardware installation. Chapter 3 and 4 contain the configuration guide to BIOS setup and information of the Support CD.



Because the motherboard specifications and the BIOS software might be updated, the content of this manual will be subject to change without notice. In case any modifications of this manual occur, the updated version will be available on ASRock website without further notice. You may find the latest VGA cards and CPU support lists on ASRock website as well. ASRock website <http://www.asrock.com>

If you require technical support related to this motherboard, please visit our website for specific information about the model you are using.

[www.asrock.com/support/index.asp](http://www.asrock.com/support/index.asp)

## 1.1 Package Contents

ASRock **970 Pro3 R2.0** Motherboard (ATX Form Factor)

ASRock **970 Pro3 R2.0** Quick Installation Guide

ASRock **970 Pro3 R2.0** Support CD

2 x Serial ATA (SATA) Data Cables (Optional)

1 x I/O Panel Shield



### **ASRock Reminds You...**

To get better performance in Windows® 8 / 8 64-bit / 7 / 7 64-bit / Vista™ / Vista™ 64-bit, it is recommended to set the BIOS option in Storage Configuration to AHCI mode. For the BIOS setup, please refer to the "User Manual" in our support CD for details.

---

## 1.2 Specifications

<b>Platform</b>	<ul style="list-style-type: none"><li>- ATX Form Factor</li><li>- All Solid Capacitor design</li></ul>
<b>CPU</b>	<ul style="list-style-type: none"><li>- Support for Socket AM3+ processors</li><li>- Support for Socket AM3 processors: AMD Phenom™ II X6 / X4 / X3 / X2 (except 920 / 940) / Athlon II X4 / X3 / X2 / Sempron processors</li><li>- Supports 8-Core CPU</li><li>- Supports UCC feature (Unlock CPU Core) (see <b>CAUTION 1</b>)</li><li>- 4 + 1 Power Phase Design</li><li>- Supports CPU up to 140W</li><li>- Supports AMD's Cool 'n' Quiet™ Technology</li><li>- FSB 2400 MHz (4.8 GT/s)</li><li>- Supports Untied Overclocking Technology</li><li>- Supports Hyper-Transport 3.0 (HT 3.0) Technology</li></ul>
<b>Chipset</b>	<ul style="list-style-type: none"><li>- Northbridge: AMD 970</li><li>- Southbridge: AMD SB950</li></ul>
<b>Memory</b>	<ul style="list-style-type: none"><li>- Dual Channel DDR3 Memory Technology</li><li>- 4 x DDR3 DIMM slots</li><li>- Support DDR3 2100+(OC)/1866(OC)/1800(OC)/1600(OC)/1333/1066/800 non-ECC, un-buffered memory (see <b>CAUTION 2</b>)</li><li>- Max. capacity of system memory: 32GB (see <b>CAUTION 3</b>)</li></ul>
<b>Expansion Slot</b>	<ul style="list-style-type: none"><li>- 2 x PCI Express 2.0 x16 slots (PCIe2 @ x16 mode; PCIe3 @ x4 mode)</li><li>- 1 x PCI Express 2.0 x1 slot</li><li>- 2 x PCI slots</li><li>- Supports AMD Quad CrossFireX™ and CrossFireX™</li></ul>
<b>Audio</b>	<ul style="list-style-type: none"><li>- 7.1 CH HD Audio with Content Protection (Realtek ALC892 Audio Codec)</li><li>- Premium Blu-ray audio support</li></ul>
<b>LAN</b>	<ul style="list-style-type: none"><li>- PCIe x1 Gigabit LAN 10/100/1000 Mb/s</li><li>- Realtek RTL8111E</li><li>- Supports Wake-On-LAN</li><li>- Supports LAN Cable Detection</li><li>- Supports Energy Efficient Ethernet 802.3az</li><li>- Supports PXE</li></ul>

<b>Rear Panel I/O</b>	<p>I/O Panel</p> <ul style="list-style-type: none"> <li>- 1 x PS/2 Mouse Port</li> <li>- 1 x PS/2 Keyboard Port</li> <li>- 6 x Ready-to-Use USB 2.0 Ports</li> <li>- 2 x Ready-to-Use USB 3.0 Ports</li> <li>- 1 x RJ-45 LAN Port with LED (ACT/LINK LED and SPEED LED)</li> <li>- HD Audio Jack: Side Speaker/Rear Speaker/Central/Bass/Line in/Front Speaker/Microphone</li> </ul>
<b>SATA3</b>	<ul style="list-style-type: none"> <li>- 6 x SATA3 6.0 Gb/s connectors, support RAID (RAID 0, RAID 1, RAID 5 and RAID 10), NCQ, AHCI and "Hot Plug" functions</li> </ul>
<b>USB 3.0</b>	<ul style="list-style-type: none"> <li>- 2 x Rear USB 3.0 ports by Etron EJ188H, support USB 1.1/2.0/3.0 up to 5Gb/s</li> <li>- 1 x Front USB 3.0 header (supports 2 USB 3.0 ports) by Etron EJ188H, supports USB 1.1/2.0/3.0 up to 5Gb/s</li> </ul>
<b>Connector</b>	<ul style="list-style-type: none"> <li>- 6 x SATA3 6.0Gb/s connectors</li> <li>- 1 x IR header</li> <li>- 1 x CIR header</li> <li>- 1 x COM port header</li> <li>- 1 x HDMI_SPDIF header</li> <li>- 1 x Power LED header</li> <li>- 2 x CPU Fan connectors (1 x 4-pin, 1 x 3-pin)</li> <li>- 2 x Chassis Fan connectors (1 x 4-pin, 1 x 3-pin)</li> <li>- 1 x Power Fan connector (3-pin)</li> <li>- 24 pin ATX power connector</li> <li>- 8 pin 12V power connector</li> <li>- Front panel audio connector</li> <li>- 3 x USB 2.0 headers (support 6 USB 2.0 ports)</li> <li>- 1 x USB 3.0 header (supports 2 USB 3.0 ports)</li> </ul>
<b>BIOS Feature</b>	<ul style="list-style-type: none"> <li>- 32Mb AMI UEFI Legal BIOS with GUI support</li> <li>- Supports "Plug and Play"</li> <li>- ACPI 1.1 Compliance Wake Up Events</li> <li>- Supports jumperfree</li> <li>- SMBIOS 2.3.1 Support</li> <li>- CPU, VCCM, NB, SB Voltage Multi-adjustment</li> </ul>
<b>Support CD</b>	<ul style="list-style-type: none"> <li>- Drivers, Utilities, AntiVirus Software (Trial Version), CyberLink MediaEspresso 6.5 Trial, Google Chrome Browser and Toolbar</li> </ul>

---

<b>Hardware Monitor</b>	<ul style="list-style-type: none"> <li>- CPU Temperature Sensing</li> <li>- Chassis Temperature Sensing</li> <li>- CPU/Chassis/Power Fan Tachometer</li> <li>- CPU/Chassis Quiet Fan</li> <li>- CPU/Chassis Fan Multi-Speed Control</li> <li>- Voltage Monitoring: +12V, +5V, +3.3V, Vcore</li> </ul>
<b>OS</b>	- Microsoft® Windows® 8 / 8 64-bit / 7 / 7 64-bit / Vista™ / Vista™ 64-bit / XP / XP 64-bit compliant (see <b>CAUTION 4</b> )
<b>Certifications</b>	<ul style="list-style-type: none"> <li>- FCC, CE, WHQL</li> <li>- ErP/EuP Ready (ErP/EuP ready power supply is required)</li> </ul>

\* For detailed product information, please visit our website: <http://www.asrock.com>

### **WARNING**

Please realize that there is a certain risk involved with overclocking, including adjusting the setting in the BIOS, applying Untied Overclocking Technology, or using third-party overclocking tools. Overclocking may affect your system's stability, or even cause damage to the components and devices of your system. It should be done at your own risk and expense. We are not responsible for possible damage caused by overclocking.



---

## **CAUTION!**

1. ASRock UCC (Unlock CPU Core) feature simplifies AMD CPU activation. As long as a simple switch of the UEFI option "ASRock UCC", you can unlock the extra CPU core to enjoy an instant performance boost. When UCC feature is enabled, the dual-core or triple-core CPU will boost to the quad-core CPU, and some CPU, including quad-core CPU, can also increase L3 cache size up to 6MB, which means you can enjoy the upgrade CPU performance with a better price. Please be noted that UCC feature is supported with AM3/AM3+ CPU only, and in addition, not every AM3/AM3+ CPU can support this function because some CPU's hidden core may be malfunctioned.
2. Whether 2100/1866/1800/1600MHz memory speed is supported depends on the AM3/AM3+ CPU you adopt. If you want to adopt DDR3 2100/1866/1800/1600 memory module on this motherboard, please refer to the memory support list on our website for the compatible memory modules. Non OC mode's DDR3 1866 is supported by AM3+ CPU.  
ASRock website: <http://www.asrock.com>
3. Due to the operating system limitation, the actual memory size may be less than 4GB for the reservation for system usage under Windows® 8 / 7 / Vista™ / XP. For Windows® 64-bit OS with 64-bit CPU, there is no such limitation. You can use ASRock XFast RAM to utilize the memory that Windows® cannot use.
4. ASRock XFast RAM is not supported by Microsoft® Windows® XP / XP 64-bit.

---

## 1.3 Unique Features

### **ASRock Extreme Tuning Utility (AXTU)**

ASRock Extreme Tuning Utility (AXTU) is an all-in-one tool to ne-tune different system functions in a user-friendly interface, which includes Hardware Monitor, Fan Control, Overclocking, OC DNA, IES and XFast RAM. In Hardware Monitor, it shows the major readings of your system. In Fan Control, it shows the fan speed and temperature for you to adjust. In Overclocking, you are allowed to overclock CPU frequency for optimal system performance. In OC DNA, you can save your OC settings as a profile and share it with your friends. Your friends then can load the OC profile to their own system to get the same OC settings. In IES (Intelligent Energy Saver), the voltage regulator can reduce the number of output phases to improve efficiency when the CPU cores are idle without sacrificing computing performance. In XFast RAM, it fully utilizes the memory space that cannot be used under Windows® OS 32-bit CPU.

### **ASRock Instant Boot**

ASRock Instant Boot allows you to turn on your PC in just a few seconds, provides a much more efficient way to save energy, time, money, and improves system running speed for your system. It leverages the S3 and S4 ACPI features which normally enable the Sleep/Standby and Hibernation modes in Windows® to shorten boot up time. By calling S3 and S4 at specific timing during the shutdown and startup process, Instant Boot allows you to enter your Windows® desktop in a few seconds.

### **ASRock Instant Flash**

ASRock Instant Flash is a BIOS flash utility embedded in Flash ROM. This convenient BIOS update tool allows you to update system BIOS without entering operating systems first like MS-DOS or Windows®. With this utility, you can press the <F6> key during the POST or the <F2> key to enter into the BIOS setup menu to access ASRock Instant Flash. Just launch this tool and save the new BIOS file to your USB flash drive, floppy disk or hard drive, then you can update your BIOS only in a few clicks without preparing an additional floppy diskette or other complicated flash utility. Please be noted that the USB flash drive or hard drive must use FAT32/16/12 file system.

---

### **ASRock APP Charger**

If you desire a faster, less restricted way of charging your Apple devices, such as iPhone/iPad/iPod Touch, ASRock has prepared a wonderful solution for you - ASRock APP Charger. Simply install the APP Charger driver, it makes your iPhone charge much quickly from your computer and up to 40% faster than before. ASRock APP Charger allows you to quickly charge many Apple devices simultaneously and even supports continuous charging when your PC enters into Standby mode (S1), Suspend to RAM (S3), hibernation mode (S4) or power off (S5). With APP Charger driver installed, you can easily enjoy the marvelous charging experience.

### **ASRock XFast USB**

ASRock XFast USB can boost USB storage device performance. The performance may depend on the properties of the device.

### **ASRock XFast LAN**

ASRock XFast LAN provides a faster internet access, which includes the benefits listed below. LAN Application Prioritization: You can configure your application's priority ideally and/or add new programs. Lower Latency in Game: After setting online game's priority higher, it can lower the latency in games. Traffic Shaping: You can watch Youtube HD videos and download simultaneously. Real-Time Analysis of Your Data: With the status window, you can easily recognize which data streams you are transferring currently.

### **ASRock XFast RAM**

ASRock XFast RAM is a new function that is included into ASRock Extreme Tuning Utility (AXTU). It fully utilizes the memory space that cannot be used under Windows® OS 32-bit CPU. ASRock XFast RAM shortens the loading time of previously visited websites, making web surfing faster than ever. And it also boosts the speed of Adobe Photoshop 5 times faster. Another advantage of ASRock XFast RAM is that it reduces the frequency of accessing your SSDs or HDDs in order to extend their lifespan.

---

### **ASRock Crashless BIOS**

ASRock Crashless BIOS allows users to update their BIOS without fear of failing. If power loss occurs during the BIOS update process, ASRock Crashless BIOS will automatically finish the BIOS update procedure after regaining power. Please note that BIOS files need to be placed in the root directory of your USB disk. Only USB2.0 ports support this feature.

### **ASRock OMG (Online Management Guard)**

Administrators are able to establish an internet curfew or restrict internet access at specified times via OMG. You may schedule the starting and ending hours of internet access granted to other users. In order to prevent users from bypassing OMG, guest accounts without permission to modify the system time are required.

### **ASRock Internet Flash**

ASRock Internet Flash searches for available UEFI firmware updates from our servers. In other words, the system can auto-detect the latest UEFI from our servers and flash them without entering Windows® OS. Please note that you must be running on a DHCP configured computer in order to enable this function.

### **ASRock On/Off Play Technology**

ASRock On/Off Play Technology allows users to enjoy the great audio experience from the portable audio devices, such like MP3 player or mobile phone to your PC, even when the PC is turned off (or in ACPI S5 mode)! This motherboard also provides a free 3.5mm audio cable (optional) that ensures users the most convenient computing environment.

### **ASRock UEFI System Browser**

ASRock UEFI system browser is a useful tool included in graphical UEFI. It can detect the devices and configurations that users are currently using in their PC. With the UEFI system browser, you can easily examine the current system configuration in UEFI setup.

---

### **ASRock Dehumidifier Function**

Users may prevent motherboard damages due to dampness by enabling “Dehumidifier Function”. When enabling Dehumidifier Function, the computer will power on automatically to dehumidify the system after entering S4/S5 state.

### **ASRock Fast Boot**

With ASRock’s exclusive Fast Boot technology, it takes less than 1.5 seconds to logon to Windows® 8 from a cold boot. No more waiting! The speedy boot will completely change your user experience and behavior.

### **ASRock X-Boost**

ASRock’s X-Boost Technology is a smart auto-overclocking function and is brilliantly designed to unlock the hidden power of your CPUs. Simply press “X” when turning on the PC, X-Boost will automatically overclock the relative components to get up to 15.77% performance boost! With the smart X-Boost, overclocking CPU can become a near one-button process.

\* The functionality of “Unlock CPU Cores” feature might vary by different processors.

### **ASRock Restart to UEFI**

Windows® 8 brings the ultimate boot up experience. The lightning boot up speed makes it hard to access the UEFI setup. ASRock Restart to UEFI technology is designed for those requiring frequent UEFI access. It allows users to easily enter the UEFI automatically when turning on the PC next time. Just simply enable this function; the PC will be assured to access the UEFI directly in the very beginning.

---

### **ASRock Good Night LED**

ASRock Good Night LED technology can offer you a better environment by extinguishing the unessential LED. By enabling Good Night LED in BIOS, the Power / HDD / LAN LED will be switched off when system is on. Not only this, Good night LED will automatically switch off Power and Keyboard LED when the system enters into Standby / Hibernation mode as well.

## 1.3 Motherboard Layout

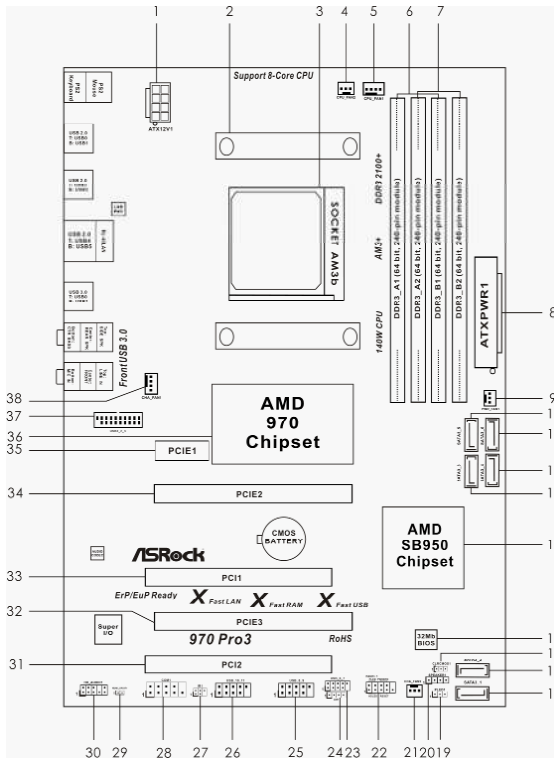

- |    |   |    |  |
|----|---|----|--|
| 1  | ATX 12V Power Connector (ATX12V1)                               | 19 | Power LED Header (PLED1)               |
| 2  | CPU Heatsink Retention Module                                   | 20 | Chassis Speaker Header (SPEAKER 1)     |
| 3  | AM3+ CPU Socket   | 21 | Chassis Fan Connector (CHA_FAN2)       |
| 4  | CPU Fan Connector (CPU_FAN2)                                    | 22 | System Panel Header (PANEL1)           |
| 5  | CPU Fan Connector (CPU_FAN1)                                    | 23 | USB 2.0 Header (USB_6_7)               |
| 6  | 2 x 240-pin DDR3 DIMM Slots<br>(Dual Channel: DDR3_A1, DDR3_B1) | 24 | Consumer Infrared Module Header (CIR1) |
| 7  | 2 x 240-pin DDR3 DIMM Slots<br>(Dual Channel: DDR3_A2, DDR3_B2) | 25 | USB 2.0 Header (USB_8_9)               |
| 8  | ATX Power Connector (ATXPWR1)                                   | 26 | USB 2.0 Header (USB_10_11)             |
| 9  | Power Fan Connector (PWR_FAN1)                                  | 27 | Infrared Module Header (IR1)           |
| 10 | SATA3 Connector (SATA3_5)                                       | 28 | COM Port Header (COM1)                 |
| 11 | SATA3 Connector (SATA3_6)                                       | 29 | HDMI_SPDIF Header (HDMI_SPDIF1)        |
| 12 | SATA3 Connector (SATA3_4)                                       | 30 | Front Panel Audio Header (HD_AUDIO1)   |
| 13 | SATA3 Connector (SATA3_3)                                       | 31 | PCI Slot (PCI2)                        |
| 14 | Southbridge Controller  | 32 | PCI Express 2.0 x16 Slot (PCIE3)       |
| 15 | SPI Flash Memory (32Mb)   | 33 | PCI Slot (PCI1)                        |
| 16 | Clear CMOS Jumper (CLRCMOS1)                                    | 34 | PCI Express 2.0 x16 Slot (PCIE2)       |
| 17 | SATA3 Connector (SATA3_2)                                       | 35 | PCI Express 2.0 x1 Slot (PCIE1)        |
| 18 | SATA3 Connector (SATA3_1)                                       | 36 | Northbridge Controller                 |
|    |   | 37 | USB 3.0 Header (USB3_2_3)              |
|    |   | 38 | Chassis Fan Connector (CHA_FAN1)       |

## 1.4 I/O Panel

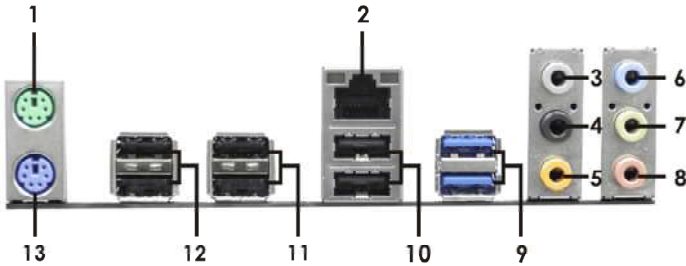

- |                           |                                |
|---------------------------|--------------------------------|
| 1 PS/2 Mouse Port (Green) | 8 Microphone (Pink)            |
| * 2 LAN RJ-45 Port        | 9 USB 3.0 Port (USB3_0_1)      |
| 3 Side Speaker (Gray)     | 10 USB 2.0 Port (USB_4_5)      |
| 4 Rear Speaker (Black)    | 11 USB 2.0 Port (USB_2_3)      |
| 5 Central / Bass (Orange) | 12 USB 2.0 Port (USB_0_1)      |
| 6 Line In (Light Blue)    | 13 PS/2 Keyboard Port (Purple) |
| ** 7 Front Speaker (Lime) |                                |

\* There are two LED next to the LAN port. Please refer to the table below for the LAN port LED indications.

### LAN Port LED Indications

Activity/Link LED	
Status	Description
Off	No Link
Blinking	Data Activity
On	Link

SPEED LED	
Status	Description
Off	10Mbps connection
Orange	100Mbps connection
Green	1Gbps connection

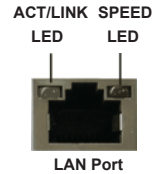

LAN Port

\*\* If you use 2-channel speaker, please connect the speaker's plug into "Front Speaker Jack". See the table below for connection details in accordance with the type of speaker you use.

### TABLE for Audio Output Connection

Audio Output Channels	Front Speaker (No. 7)	Rear Speaker (No. 4)	Central / Bass (No. 5)	Side Speaker (No. 3)
2	V	--	--	--
4	V	V	--	--
6	V	V	V	--
8	V	V	V	V

To enable Multi-Streaming function, you need to connect a front panel audio cable to the front panel audio header. After restarting your computer, you will find "Mixer" tool on your system. Please select "Mixer Toolbox" , click "Enable playback multi-streaming", and click "ok".

Choose "2CH", "4CH", "6CH", or "8CH" and then you are allowed to select "Realtek HDA Primary output" to use Rear Speaker, Central/Bass, and Front Speaker, or select "Realtek HDA Audio 2nd output" to use front panel audio.



---

## 2. Installation

This is an ATX form factor motherboard. Before you install the motherboard, study the configuration of your chassis to ensure that the motherboard fits into it.

### Pre-installation Precautions

Take note of the following precautions before you install motherboard components or change any motherboard settings.



Before you install or remove any component, ensure that the power is switched off or the power cord is detached from the power supply. Failure to do so may cause severe damage to the motherboard, peripherals, and/or components.

1. Unplug the power cord from the wall socket before touching any component.
2. To avoid damaging the motherboard components due to static electricity, NEVER place your motherboard directly on the carpet or the like. Also remember to use a grounded wrist strap or touch a safety grounded object before you handle components.
3. Hold components by the edges and do not touch the ICs.
4. Whenever you uninstall any component, place it on a grounded anti-static pad or in the bag that comes with the component.
5. When placing screws into the screw holes to secure the motherboard to the chassis, please do not over-tighten the screws! Doing so may damage the motherboard.

---

## 2.1 CPU Installation

- Step 1. Unlock the socket by lifting the lever up to a 90° angle.
- Step 2. Position the CPU directly above the socket such that the CPU corner with the golden triangle matches the socket corner with a small triangle.
- Step 3. Carefully insert the CPU into the socket until it fits in place.



The CPU fits only in one correct orientation. DO NOT force the CPU into the socket to avoid bending of the pins.

- Step 4. When the CPU is in place, press it firmly on the socket while you push down the socket lever to secure the CPU. The lever clicks on the side tab to indicate that it is locked.



**STEP 1:**  
Lift Up The Socket Lever

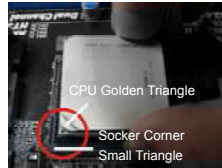

**STEP 2 / STEP 3:**  
Match The CPU Golden Triangle  
To The Socket Corner Small  
Triangle



**STEP 4:**  
Push Down And Lock  
The Socket Lever

## 2.2 Installation of CPU Fan and Heatsink

After you install the CPU into this motherboard, it is necessary to install a larger heatsink and cooling fan to dissipate heat. You also need to spray thermal grease between the CPU and the heatsink to improve heat dissipation. Make sure that the CPU and the heatsink are securely fastened and in good contact with each other. Then connect the CPU fan to the CPU FAN connector (CPU\_FAN1, see Page 15, No. 5 or CPU\_FAN2, see Page 15, No. 4). For proper installation, please kindly refer to the instruction manuals of the CPU fan and the heatsink.

---

## 2.3 Installation of Memory Modules (DIMM)

This motherboard provides four 240-pin DDR3 (Double Data Rate 3) DIMM slots, and supports Dual Channel Memory Technology. For dual channel configuration, you always need to install **identical** (the same brand, speed, size and chip-type) DDR3 DIMM pair in the slots. In other words, you have to install **identical** DDR3 DIMM pair in **Dual Channel** (DDR3\_A1 and DDR3\_B1; Black slots; see p.15 No.6) or **identical** DDR3 DIMM pair in **Dual Channel** (DDR3\_A2 and DDR3\_B2; Black slots; see p.15 No.7), so that Dual Channel Memory Technology can be activated. This motherboard also allows you to install four DDR3 DIMMs for dual channel configuration, and please install **identical** DDR3 DIMMs in all four slots. You may refer to the Dual Channel Memory Configuration Table below.

### Dual Channel Memory Configurations

	DDR3_A1 (Black Slot)	DDR3_A2 (Black Slot)	DDR3_B1 (Black Slot)	DDR3_B2 (Black Slot)
(1)	Populated	-	Populated	-
(2)	-	Populated	-	Populated
(3)*	Populated	Populated	Populated	Populated

- \* For the configuration (3), please install **identical** DDR3 DIMMs in all four slots.



1. Please install the memory module into the slots DDR3\_A2 and DDR3\_B2 for the first priority.
2. If you want to install two memory modules, for optimal compatibility and reliability, it is recommended to install them either in the set of slots DDR3\_A1 and DDR3\_B1, or in the set of slots DDR3\_A2 and DDR3\_B2.
3. If only one memory module or three memory modules are installed in the DDR3 DIMM slots on this motherboard, it is unable to activate the Dual Channel Memory Technology.
4. If a pair of memory modules is NOT installed in the same Dual Channel, for example, installing a pair of memory modules in DDR3\_A1 and DDR3\_A2, it is unable to activate the Dual Channel Memory Technology .
5. It is not allowed to install a DDR or DDR2 memory module into DDR3 slot; otherwise, this motherboard and DIMM may be damaged.
6. If you adopt DDR3 2100/1866/1800/1600 memory modules on this motherboard, it is recommended to install them on DDR3\_A2 and DDR3\_B2 slots.

---

## Installing a DIMM



Please make sure to disconnect power supply before adding or removing DIMMs or the system components.

- Step 1. Unlock a DIMM slot by pressing the retaining clips outward.
- Step 2. Align a DIMM on the slot such that the notch on the DIMM matches the break on the slot.

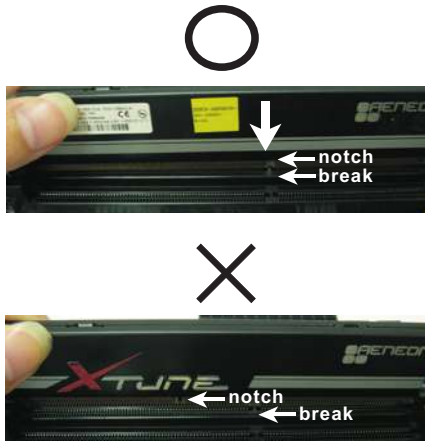

The DIMM only fits in one correct orientation. It will cause permanent damage to the motherboard and the DIMM if you force the DIMM into the slot at incorrect orientation.

- Step 3. Firmly insert the DIMM into the slot until the retaining clips at both ends fully snap back in place and the DIMM is properly seated.

---

## 2.4 Expansion Slots (PCI and PCI Express Slots)

There are 2 PCI slots and 3 PCI Express slots on this motherboard.

**PCI Slots:** PCI slots are used to install expansion cards that have the 32-bit PCI interface.

**PCI Express Slots:**

PCIE1 (PCI Express x1 slot) is used for PCI Express cards with x1 lane width cards, such as Gigabit LAN card and SATA2 card.

PCIE2 (PCI Express x16 slot) is used for PCI Express x16 lane width graphics cards, or used to install PCI Express graphics cards to support CrossFireX™ function.

PCIE3 (PCI Express x16 slot) is used for PCI Express x4 lane width cards, or used to install PCI Express graphics cards to support CrossFireX™ function.



1. In single VGA card mode, it is recommended to install a PCI Express x16 graphics card on PCIE2 slot.
2. In CrossFireX™ mode, please install PCI Express x16 graphics cards on PCIE2 and PCIE3 slots. Therefore, PCIE2 slot will work at x16 bandwidth while PCIE3 slot will work at x4 bandwidth.
3. Please connect a chassis fan to motherboard chassis fan connector (CHA\_FAN1 or CHA\_FAN2) when using multiple graphics cards for better thermal environment.

### Installing an expansion card

- Step 1. Before installing the expansion card, please make sure that the power supply is switched off or the power cord is unplugged. Please read the documentation of the expansion card and make necessary hardware settings for the card before you start the installation.
- Step 2. Remove the system unit cover (if your motherboard is already installed in a chassis).
- Step 3. Remove the bracket facing the slot that you intend to use. Keep the screws for later use.
- Step 4. Align the card connector with the slot and press firmly until the card is completely seated on the slot.
- Step 5. Fasten the card to the chassis with screws.
- Step 6. Replace the system cover.

---

## 2.5 CrossFireX™ and Quad CrossFireX™ Operation Guide

This motherboard supports CrossFireX™ and Quad CrossFireX™ feature. CrossFireX™ technology offers the most advantageous means available of combining multiple high performance Graphics Processing Units (GPU) in a single PC. Combining a range of different operating modes with intelligent software design and an innovative interconnect mechanism, CrossFireX™ enables the highest possible level of performance and image quality in any 3D application. Currently CrossFireX™ feature is supported with Windows® XP with Service Pack 2 / Vista™ / 7 / 8 OS. Quad CrossFireX™ feature is supported with Windows® Vista™ / 7 / 8 OS only. Please check AMD website for AMD CrossFireX™ driver updates.



1. If a customer incorrectly configures their system they will not see the performance benefits of CrossFireX™. All three CrossFireX™ components, a CrossFireX™ Ready graphics card, a CrossFireX™ Ready motherboard and a CrossFireX™ Edition co-processor graphics card, must be installed correctly to benefit from the CrossFireX™ multi-GPU platform.
2. If you pair a 12-pipe CrossFireX™ Edition card with a 16-pipe card, both cards will operate as 12-pipe cards while in CrossFireX™ mode.

### 2.5.1 Graphics Card Setup

#### 2.5.1.1 Installing Two CrossFireX™-Ready Graphics Cards



Different CrossFireX™ cards may require different methods to enable CrossFireX™ feature. For other CrossFireX™ cards that AMD has released or will release in the future, please refer to AMD graphics card manuals for detailed installation guide.

- Step 1. Insert one Radeon graphics card into PCIE2 slot and the other Radeon graphics card to PCIE3 slot. Make sure that the cards are properly seated on the slots.



---

Step 2. Connect two Radeon graphics cards by installing a CrossFire Bridge on the CrossFire Bridge Interconnects on the top of the Radeon graphics cards. (The CrossFire Bridge is provided with the graphics card you purchase, not bundled with this motherboard. Please refer to your graphics card vendor for details.)



**CrossFire Bridge**



or



Step 3. Connect the DVI monitor cable to the DVI connector on the Radeon graphics card on PCIE2 slot. (You may use the DVI to D-Sub adapter to convert the DVI connector to D-Sub interface, and then connect the D-Sub monitor cable to the DVI to D-Sub adapter.)

---

## 2.5.2 Driver Installation and Setup

- Step 1. Power on your computer and boot into OS.
- Step 2. Remove the AMD driver if you have any VGA driver installed in your system.



The Catalyst Uninstaller is an optional download. We recommend using this utility to uninstall any previously installed Catalyst drivers prior to installation. Please check AMD website for AMD driver updates.

- Step 3. Install the required drivers to your system.

### For Windows® XP OS:

A. AMD recommends Windows® XP Service Pack 2 or higher to be installed (If you have Windows® XP Service Pack 2 or higher installed in your system, there is no need to download it again):

<http://www.microsoft.com/windowsxp/sp2/default.mspx>

B. You must have Microsoft .NET Framework installed prior to downloading and installing the CATALYST Control Center. Please check Microsoft website for details.

### For Windows® 8 / 7 / Vista™ OS:

Install the CATALYST Control Center. Please check AMD website for details.

- Step 4. Restart your computer.
- Step 5. Install the VGA card drivers to your system, and restart your computer. Then you will find “ATI Catalyst Control Center” on your Windows® taskbar.



ATI Catalyst Control Center

- Step 6. Double-click “ATI Catalyst Control Center”. Click “View”, select “CrossFire™”, and then check the item “Enable CrossFire™”. Select “2 GPUs” and click “Apply” (if you install two Radeon graphics cards).







Although you have selected the option “Enable CrossFire™”, the CrossFireX™ function may not work actually. Your computer will automatically reboot. After restarting your computer, please confirm whether the option “Enable CrossFire™” in “ATI Catalyst Control Center” is selected or not; if not, please select it again, and then you are able to enjoy the benefit of CrossFireX™ feature.

Step 7. You can freely enjoy the benefit of CrossFireX™ or Quad CrossFireX™ feature.

- \* CrossFireX™ appearing here is a registered trademark of AMD Technologies Inc., and is used only for identification or explanation and to the owners' benefit, without intent to infringe.
- \* For further information of AMD CrossFireX™ technology, please check AMD website for updates and details.

## 2.6 Surround Display Feature

This motherboard supports Surround Display upgrade. With the external add-on PCI Express VGA cards, you can easily enjoy the benefits of Surround Display feature. For the detailed instruction, please refer to the document at the following path in the Support CD:

..\ Surround Display Information

---

## 2.7 ASRock Smart Remote Installation Guide

ASRock Smart Remote is only used for ASRock motherboard with CIR header. Please refer to below procedures for the quick installation and usage of ASRock Smart Remote.

- Step1. Find the CIR header located next to the USB 2.0 header on ASRock motherboard.



- USB 2.0 header (9-pin, black)
- CIR header (4-pin, gray)

- Step2. Connect the front USB cable to the USB 2.0 header (as below, pin 1-5) and the CIR header. Please make sure the wire assignments and the pin assignments are matched correctly.

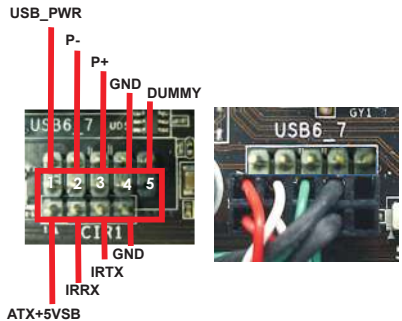

- Step3. Install Multi-Angle CIR Receiver to the front USB port.
- Step4. Boot up your system. Press <F2> or <Del> to enter BIOS Setup Utility. Make sure the option "CIR Controller" is setting at [Enabled]. (Advanced -> Super IO Configuration -> CIR Controller -> [Enabled])



If you cannot find this option, please shut down your system and install Multi-Angle CIR Receiver to the other front USB port then try again.

- Step5. Enter Windows. Execute ASRock support CD and install CIR Driver. (It is listed at the bottom of driver list.)

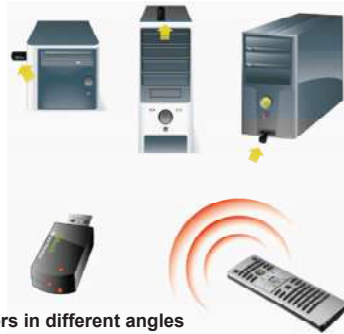

1. Only one of the front USB port can support CIR function. When the CIR function is enabled, the other port will remain USB function.
2. Multi-Angle CIR Receiver is used for front USB only. Please do not use the rear USB bracket to connect it on the rear panel. Multi-Angle CIR Receiver can receive the multi-direction infrared signals (top, down and front), which is compatible with most of the chassis on the market.
3. The Multi-Angle CIR Receiver does not support Hot-Plug function. Please install it before you boot the system.



\* ASRock Smart Remote is only supported by some of ASRock motherboards. Please refer to ASRock website for the motherboard support list: <http://www.asrock.com>

---

## 2.8 Jumpers Setup

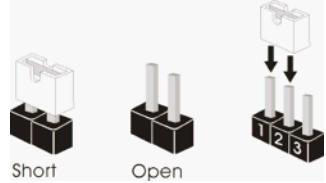
The illustration shows how jumpers are setup. When the jumper cap is placed on pins, the jumper is “Short”. If no jumper cap is placed on pins, the jumper is “Open”. The illustration shows a 3-pin jumper whose pin1 and pin2 are “Short” when jumper cap is placed on these 2 pins.



Jumper	Setting	Description
Clear CMOS Jumper (CLRCMOS1) (see p.15, No. 16)	<b>1_2</b>  Default	<b>2_3</b>  Clear CMOS

Note: CLRCMOS1 allows you to clear the data in CMOS. To clear and reset the system parameters to default setup, please turn off the computer and unplug the power cord from the power supply. After waiting for 15 seconds, use a jumper cap to short pin2 and pin3 on CLRCMOS1 for 5 seconds. However, please do not clear the CMOS right after you update the BIOS. If you need to clear the CMOS when you just finish updating the BIOS, you must boot up the system first, and then shut it down before you do the clear-CMOS action. Please be noted that the password, date, time, user default profile, 1394 GUID and MAC address will be cleared only if the CMOS battery is removed.

## 2.9 Onboard Headers and Connectors



Onboard headers and connectors are NOT jumpers. Do NOT place jumper caps over these headers and connectors. Placing jumper caps over the headers and connectors will cause permanent damage of the motherboard!

### Serial ATA3 Connectors

(SATA3\_1: see p.15, No. 18)

(SATA3\_2: see p.15, No. 17)

(SATA3\_3: see p.15, No. 13)

(SATA3\_4: see p.15, No. 12)

(SATA3\_5: see p.15, No. 10)

(SATA3\_6: see p.15, No. 11)



These six Serial ATA3 (SATA3) connectors support SATA data cables for internal storage devices. The current SATA3 interface allows up to 6.0 Gb/s data transfer rate.

### Serial ATA (SATA) Data Cable (Optional)



Either end of the SATA data cable can be connected to the SATA / SATA2 / SATA3 hard disk or the SATA3 connector on this motherboard.

### USB 2.0 Headers

(9-pin USB\_6\_7)

(see p.15 No. 23)

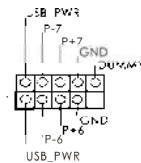

(9-pin USB\_8\_9)

(see p.15 No. 25)

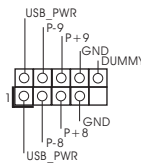

(9-pin USB\_10\_11)

(see p.15 No. 26)

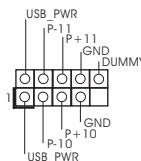

Besides six default USB 2.0 ports on the I/O panel, there are three USB 2.0 headers on this motherboard. Each USB 2.0 header can support two USB 2.0 ports.

### Infrared Module Header

(5-pin IR1)

(see p.15 No. 27)

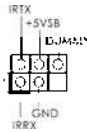

This header supports an optional wireless transmitting and receiving infrared module.

### Consumer Infrared Module Header

(4-pin CIR1)

(see p.15 No. 24)



This header can be used to connect the remote controller receiver.

### Front Panel Audio Header

(9-pin HD\_AUDIO1)

(see p.15 No. 30)

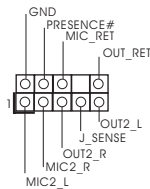

This is an interface for the front panel audio cable that allows convenient connection and control of audio devices.



1. High Definition Audio supports Jack Sensing, but the panel wire on the chassis must support HDA to function correctly. Please follow the instruction in our manual and chassis manual to install your system.
2. If you use AC'97 audio panel, please install it to the front panel audio header as below:

- A. Connect Mic\_IN (MIC) to MIC2\_L.
- B. Connect Audio\_R (RIN) to OUT2\_R and Audio\_L (LIN) to OUT2\_L.
- C. Connect Ground (GND) to Ground (GND).
- D. MIC\_RET and OUT\_RET are for HD audio panel only. You don't need to connect them for AC'97 audio panel.
- E. To activate the front mic.

For Windows® XP / XP 64-bit OS:

Select "Mixer". Select "Recorder". Then click "FrontMic".

For Windows® 8 / 8 64-bit / 7 / 7 64-bit / Vista™ / Vista™ 64-bit OS:

Go to the "FrontMic" Tab in the Realtek Control panel. Adjust "Recording Volume".

### System Panel Header

(9-pin PANEL1)

(see p.15 No. 22)

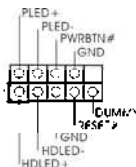

This header accommodates several system front panel functions.



Connect the power switch, reset switch and system status indicator on the chassis to this header according to the pin assignments below. Note the positive and negative pins before connecting the cables.

**PWRBTN (Power Switch):**

Connect to the power switch on the chassis front panel. You may configure the way to turn off your system using the power switch.

**RESET (Reset Switch):**

Connect to the reset switch on the chassis front panel. Press the reset switch to restart the computer if the computer freezes and fails to perform a normal restart.

**PLED (System Power LED):**

Connect to the power status indicator on the chassis front panel. The LED is on when the system is operating. The LED keeps blinking when the system is in S1 sleep state. The LED is off when the system is in S3/S4 sleep state or powered off (S5).

**HDLED (Hard Drive Activity LED):**

Connect to the hard drive activity LED on the chassis front panel. The LED is on when the hard drive is reading or writing data.

The front panel design may differ by chassis. A front panel module mainly consists of power switch, reset switch, power LED, hard drive activity LED, speaker and etc. When connecting your chassis front panel module to this header, make sure the wire assignments and the pin assignments are matched correctly.

**Chassis Speaker Header**

(4-pin SPEAKER 1)  
(see p.15 No. 20)

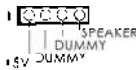

Please connect the chassis speaker to this header.

**Power LED Header**

(3-pin PLED 1)  
(see p.15 No. 19)



Please connect the chassis power LED to this header to indicate system power status. The LED is on when the system is operating. The LED keeps blinking in S1 state. The LED is off in S3/S4 state or S5 state (power off).

**Chassis and Power Fan Connectors**

(4-pin CHA\_FAN1)  
(see p.15 No. 38)



Please connect the fan cables to the fan connectors and match the black wire to the ground pin.

(3-pin CHA\_FAN2)  
(see p.15 No. 21)

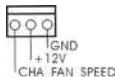

(3-pin PWR\_FAN1)  
(see p.15 No. 9)

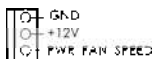

### CPU Fan Connectors

(4-pin CPU\_FAN1)

(see p.15 No. 5)

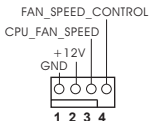

Please connect the CPU fan cable to the connector and match the black wire to the ground pin.



Though this motherboard provides 4-Pin CPU fan (Quiet Fan) support, the 3-Pin CPU fan still can work successfully even without the fan speed control function. If you plan to connect the 3-Pin CPU fan to the CPU fan connector on this motherboard, please connect it to Pin 1-3.

Pin 1-3 Connected

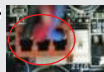

3-Pin Fan Installation

(3-pin CPU\_FAN2)

(see p.15 No. 4)

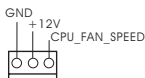

### ATX Power Connector

(24-pin ATXPWR1)

(see p.15 No. 8)

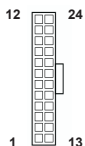

Please connect an ATX power supply to this connector.



Though this motherboard provides 24-pin ATX power connector, it can still work if you adopt a traditional 20-pin ATX power supply. To use the 20-pin ATX power supply, please plug your power supply along with Pin 1 and Pin 13.



20-Pin ATX Power Supply Installation

### ATX 12V Power Connector

(8-pin ATX12V1)

(see p.15 No. 1)



Please connect an ATX 12V power supply to this connector.



Though this motherboard provides 8-pin ATX 12V power connector, it can still work if you adopt a traditional 4-pin ATX 12V power supply. To use the 4-pin ATX power supply, please plug your power supply along with Pin 1 and Pin 5.



4-Pin ATX 12V Power Supply Installation



---

### Serial port Header

(9-pin COM1)

(see p.15 No.28)

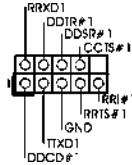

This COM1 header supports a serial port module.

---

### HDMI\_SPDIF Header

(2-pin HDMI\_SPDIF1)

(see p.15 No. 29)



HDMI\_SPDIF header, providing SPDIF audio output to HDMI VGA card, allows the system to connect HDMI Digital TV/ projector/LCD devices. Please connect the HDMI\_SPDIF connector of HDMI VGA card to this header.

---

### USB 3.0 Header

(19-pin USB3\_2\_3)

(see p.15 No. 37)

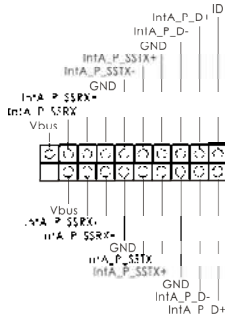

Besides two default USB 3.0 ports on the I/O panel, there is one USB 3.0 header on this motherboard. This USB 3.0 header can support two USB 3.0 ports.

---

## 2.10 Serial ATA3 (SATA3) Hard Disks Installation

This motherboard adopts AMD SB950 chipset that supports Serial ATA3 (SATA3) hard disks and RAID (RAID 0, RAID 1, RAID 5 and RAID 10) functions. You may install SATA3 hard disks on this motherboard for internal storage devices. This section will guide you to install the SATA3 hard disks.

STEP 1: Install the SATA3 hard disks into the drive bays of your chassis.

STEP 2: Connect the SATA power cable to the SATA3 hard disk.

STEP 3: Connect one end of the SATA data cable to the motherboard's SATA3 connector.

STEP 4: Connect the other end of the SATA data cable to the SATA3 hard disk.

## 2.11 Hot Plug and Hot Swap Functions for SATA3 HDDs

This motherboard supports Hot Plug and Hot Swap functions for SATA3 in RAID / AHCI mode. AMD SB950 chipset provides hardware support for Advanced Host controller Interface (AHCI), a new programming interface for SATA host controllers developed thru a joint industry effort.



### NOTE

#### What is Hot Plug Function?

If the SATA3 HDDs are NOT set for RAID configuration, it is called "Hot Plug" for the action to insert and remove the SATA3 HDDs while the system is still power-on and in working condition.

However, please note that it cannot perform Hot Plug if the OS has been installed into the SATA3 HDD.

#### What is Hot Swap Function?

If SATA3 HDDs are built as RAID 1 or RAID 5 then it is called "Hot Swap" for the action to insert and remove the SATA3 HDDs while the system is still power-on and in working condition.

---

## 2.12 SATA3 HDD Hot Plug Feature and Operation Guide

This motherboard supports Hot Plug feature for SATA3 HDD in RAID / AHCI mode. Please read below operation guide of Hot Plug feature carefully. Before you process the SATA3 HDD Hot Plug, please check below cable accessories from the motherboard gift box pack.

A. 7-pin SATA data cable

B. SATA power cable with SATA 15-pin power connector interface

A. SATA data cable (Red)

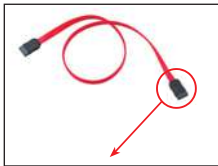

SATA 7-pin  
connector

B. SATA power cable

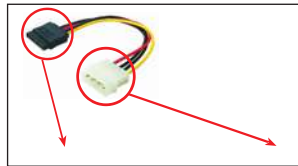

The SATA 15-pin power  
connector (Black) connect  
to SATA3 HDD

1x4-pin conventional  
power connector (White)  
connect to power supply

### Caution

1. Without SATA 15-pin power connector interface, the SATA3 Hot Plug cannot be processed.
2. Even some SATA3 HDDs provide both SATA 15-pin power connector and IDE 1x4-pin conventional power connector interfaces, the IDE 1x4-pin conventional power connector interface is definitely not able to support Hot Plug and will cause the HDD damage and data loss.

### Points of attention, before you process the Hot Plug:

1. Below operation procedure is designed only for our motherboard, which supports SATA3 HDD Hot Plug.
  - \* The SATA3 Hot Plug feature might not be supported by the chipset because of its limitation, the SATA3 Hot Plug support information of our motherboard is indicated in the product spec on our website: [www.asrock.com](http://www.asrock.com)
2. Make sure your SATA3 HDD can support Hot Plug function from your dealer or HDD user manual. The SATA3 HDD, which cannot support Hot Plug function, will be damaged under the Hot Plug operation.
3. Please make sure the SATA3 HDD is installed into system properly. The latest SATA3 driver is available on our support website: [www.asrock.com](http://www.asrock.com)
4. Make sure to use the SATA power cable & data cable, which are from our motherboard package.
5. Please follow below instructions step by step to reduce the risk of HDD crash or data loss.

---

## How to Hot Plug a SATA3 HDD:

Points of attention, before you process the Hot Plug:

Please do follow below instruction sequence to process the Hot Plug, improper procedure will cause the SATA3 HDD damage and data loss.

**Step 1** Please connect SATA power cable 1x4-pin end (White) to the power supply 1x4-pin cable.

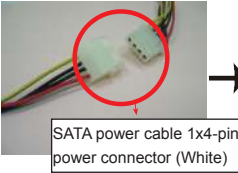

**Step 2** Connect SATA data cable to the motherboard's SATAII / SATA3 connector.

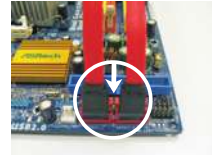

**Step 3** Connect SATA 15-pin power cable connector (Black) end to SATA3 HDD.



**Step 4** Connect SATA data cable to the SATA3 HDD.



## How to Hot Unplug a SATA3 HDD:

Points of attention, before you process the Hot Unplug:

Please do follow below instruction sequence to process the Hot Unplug, improper procedure will cause the SATA3 HDD damage and data loss.

**Step 1** Unplug SATA data cable from SATA3 HDD side.



**Step 2** Unplug SATA 15-pin power cable connector (Black) from SATA3 HDD side.



---

## 2.13 Driver Installation Guide

To install the drivers to your system, please insert the support CD to your optical drive first. Then, the drivers compatible to your system can be auto-detected and listed on the support CD driver page. Please follow the order from up to bottom side to install those required drivers. Therefore, the drivers you install can work properly.

## 2.14 Installing Windows® 8 / 8 64-bit / 7 / 7 64-bit / Vista™ / Vista™ 64-bit / XP / XP 64-bit With RAID Functions

If you want to install Windows® 8 / 8 64-bit / 7 / 7 64-bit / Vista™ / Vista™ 64-bit / XP / XP 64-bit on a RAID disk composed of 2 or more SATA3 HDDs with RAID functions, please follow below procedures according to the OS you install.

### 2.14.1 Installing Windows® XP / XP 64-bit With RAID Functions

If you want to install Windows® XP / XP 64-bit on a RAID disk composed of 2 or more SATA3 HDDs with RAID functions, please follow below steps.

#### **STEP 1: Set up UEFI.**

- A. Enter UEFI SETUP UTILITY → Advanced screen → Storage Configuration.
- B. Set the “SATA Mode” option to [RAID].

#### **STEP 2: Make a SATA3 Driver Diskette. (Please use an USB floppy or a floppy disk.)**

- A. Insert the ASRock Support CD into your optical drive to boot your system.
- B. During POST at the beginning of system boot-up, press <F11> key, and then a window for boot devices selection appears. Please select CD-ROM as the boot device.
- C. When you see the message on the screen, “Generate Serial ATA driver diskette [YN]?”, press <Y>.
- D. Then you will see these messages,  
**Please insert a diskette into the floppy drive.**  
**WARNING! Formatting the floppy diskette will lose ALL data in it!**  
**Start to format and copy files [YN]?**  
Please insert a floppy diskette into the floppy drive, and press any key.
- E. The system will start to format the floppy diskette and copy SATA3 drivers into the floppy diskette.

---

**STEP 3: Use “RAID Installation Guide” to set RAID configuration.**

Before you start to configure RAID function, you need to check the RAID installation guide in the Support CD for proper configuration. Please refer to the BIOS RAID installation guide part of the document in the following path in the Support CD:

.. \ RAID Installation Guide

**STEP 4: Install Windows® XP / XP 64-bit OS on your system.**

After step 1, 2, 3, you can start to install Windows® XP / XP 64-bit OS on your system. At the beginning of Windows® setup, press F6 to install a third-party RAID driver. When prompted, insert the SATA3 driver diskette containing the AMD RAID driver. After reading the floppy disk, the driver will be presented. Select the driver to install according to the OS you install.

## **2.14.2 Installing Windows® 8 / 8 64-bit / 7 / 7 64-bit / Vista™ / Vista™ 64-bit With RAID Functions**

If you want to install Windows® 8 / 8 64-bit / 7 / 7 64-bit / Vista™ / Vista™ 64-bit on a RAID disk composed of 2 or more SATA3 HDDs with RAID functions, please follow below steps.

**STEP 1: Set up UEFI.**

- A. Enter UEFI SETUP UTILITY → Advanced screen → Storage Configuration.
- B. Set the “SATA Mode” option to [RAID].

**STEP 2: Use “RAID Installation Guide” to set RAID configuration.**

Before you start to configure RAID function, you need to check the RAID installation guide in the Support CD for proper configuration. Please refer to the BIOS RAID installation guide part of the document in the following path in the Support CD:

.. \ RAID Installation Guide

**STEP 3: Make a SATA3 Driver Diskette. (Please use an USB floppy or a floppy disk.)**

Make a SATA3 driver diskette by following section 2.14.1 step 2 on page 37.

**STEP 4: Install Windows® 8 / 8 64-bit / 7 / 7 64-bit / Vista™ / Vista™ 64-bit OS on your system.**

---

## 2.15 Installing Windows® 8 / 8 64-bit / 7 / 7 64-bit / Vista™ / Vista™ 64-bit / XP / XP 64-bit Without RAID Functions

If you want to install Windows® 8 / 8 64-bit / 7 / 7 64-bit / Vista™ / Vista™ 64-bit / XP / XP 64-bit OS on your SATA3 HDDs without RAID functions, please follow below procedures according to the OS you install.

### 2.15.1 Installing Windows® XP / XP 64-bit Without RAID Functions

If you want to install Windows® XP / XP 64-bit on your SATA3 HDDs without RAID functions, please follow below steps.

#### Using SATA3 HDDs with NCQ and Hot Plug functions (AHCI mode)

##### **STEP 1: Set up UEFI.**

- A. Enter UEFI SETUP UTILITY → Advanced screen → Storage Configuration.
- B. Set the “SATA Mode” option to [AHCI].

##### **STEP 2: Make a SATA3 Driver Diskette. (Please use an USB floppy or a floppy disk.)**

Make a SATA3 driver diskette by following section 2.14.1 step 2 on page 37.

##### **STEP 3: Install Windows® XP / XP 64-bit OS on your system.**

You can start to install Windows® XP / XP 64-bit OS on your system. At the beginning of Windows® setup, press F6 to install a third-party AHCI driver. When prompted, insert the SATA3 driver diskette containing the AMD AHCI driver. After reading the floppy disk, the driver will be presented. Select the driver to install according to the OS you install.

#### Using SATA3 HDDs without NCQ and Hot Plug functions (IDE mode)

##### **STEP 1: Set up UEFI.**

- A. Enter UEFI SETUP UTILITY → Advanced screen → Storage Configuration.
- B. Set the “SATA Mode” option to [IDE].

##### **STEP 2: Install Windows® XP / XP 64-bit OS on your system.**

---

## 2.15.2 Installing Windows® 8 / 8 64-bit / 7 / 7 64-bit / Vista™ / Vista™ 64-bit Without RAID Functions

If you want to install Windows® 8 / 8 64-bit / 7 / 7 64-bit / Vista™ / Vista™ 64-bit on your SATA3 HDDs without RAID functions, please follow below steps.

### Using SATA3 HDDs with NCQ and Hot Plug functions (AHCI mode)

#### STEP 1: Set up UEFI.

- A. Enter UEFI SETUP UTILITY → Advanced screen → Storage Configuration.
- B. Set the “SATA Mode” option to [AHCI].

**STEP 2: Install Windows® 8 / 8 64-bit / 7 / 7 64-bit / Vista™ / Vista™ 64-bit OS on your system.**

### Using SATA3 HDDs without NCQ and Hot Plug functions (IDE mode)

#### STEP 1: Set up UEFI.

- A. Enter UEFI SETUP UTILITY → Advanced screen → Storage Configuration.
- B. Set the “SATA Mode” option to [IDE].

**STEP 2: Install Windows® 8 / 8 64-bit / 7 / 7 64-bit / Vista™ / Vista™ 64-bit OS on your system.**

## 2.16 Untied Overclocking Technology

This motherboard supports Untied Overclocking Technology, which means during overclocking, FSB enjoys better margin due to fixed PCI / PCIE buses. Before you enable Untied Overclocking function, please enter “Overclock Mode” option of UEFI setup to set the selection from [Auto] to [Manual]. Therefore, CPU FSB is untied during overclocking, but PCI / PCIE buses are in the fixed mode so that FSB can operate under a more stable overclocking environment.



Please refer to the warning on page 8 for the possible overclocking risk before you apply Untied Overclocking Technology.



---

## 3. UEFI SETUP UTILITY

### 3.1 Introduction

This section explains how to use the UEFI SETUP UTILITY to configure your system. The SPI Memory on the motherboard stores the UEFI SETUP UTILITY. You may run the UEFI SETUP UTILITY when you start up the computer. Please press <F2> or <Del> during the Power-On-Self-Test (POST) to enter the UEFI SETUP UTILITY, otherwise, POST will continue with its test routines.

If you wish to enter the UEFI SETUP UTILITY after POST, restart the system by pressing <Ctl> + <Alt> + <Delete>, or by pressing the reset button on the system chassis. You may also restart by turning the system off and then back on.



Because the UEFI software is constantly being updated, the following UEFI setup screens and descriptions are for reference purpose only, and they may not exactly match what you see on your screen.

#### 3.1.1 UEFI Menu Bar

The top of the screen has a menu bar with the following selections:

- Main**            To set up the system time/date information
- OC Tweaker**    To set up overclocking features
- Advanced**      To set up the advanced UEFI features
- H/W Monitor**   To display current hardware status
- Boot**            To set up the default system device to locate and load the Operating System
- Security**        To set up the security features
- Exit**            To exit the current screen or the UEFI SETUP UTILITY

Use <←> key or <→> key to choose among the selections on the menu bar, and then press <Enter> to get into the sub screen.

---

### 3.1.2 Navigation Keys

Please check the following table for the function description of each navigation key.

<b>Navigation Key(s)</b>	<b>Function Description</b>
← / →	Moves cursor left or right to select Screens
↑ / ↓	Moves cursor up or down to select items
+ / -	To change option for the selected items
<Tab>	Switch to next function
<Enter>	To bring up the selected screen
<PGUP>	Go to the previous page
<PGDN>	Go to the next page
<HOME>	Go to the top of the screen
<END>	Go to the bottom of the screen
<F1>	To display the General Help Screen
<F7>	Discard changes and exit the UEFI SETUP UTILITY
<F9>	Load optimal default values for all the settings
<F10>	Save changes and exit the UEFI SETUP UTILITY
<F12>	Print screen
<ESC>	Jump to the Exit Screen or exit the current screen

---

## 3.2 Main Screen

When you enter the UEFI SETUP UTILITY, the Main screen will appear and display the system overview.



### System Browser

System Browser can let you easily check your current system configuration in UEFI setup.

### OMG (Online Management Guard)

Administrators are able to establish an internet curfew or restrict internet access at specified times via OMG. You may schedule the starting and ending hours of internet access granted to other users. In order to prevent users from bypassing OMG, guest accounts without permission to modify the system time are required.

---

### 3.3 OC Tweaker Screen

In the OC Tweaker screen, you can set up overclocking features.



#### OC Mode

Use this to select OC Mode. Configuration options: [Manual] and [CPU OC Mode]. The default value is [Manual].

#### CPU Configuration

##### Overclock Mode

Use this to select Overclock Mode. Configuration options: [Auto] and [Manual]. The default value is [Auto].

##### Spread Spectrum

This item should always be [Auto] for better system stability.

##### ASRock UCC

ASRock UCC (Unlock CPU Core) feature simplifies AMD CPU activation. As long as a simple switch of the UEFI option "ASRock UCC", you can unlock the extra CPU core to enjoy an instant performance boost. When UCC feature is enabled, the dual-core or triple-core CPU will boost to the quad-core CPU, and some CPU, including quad-core CPU, can also increase L3 cache size up to 6MB, which means you can enjoy the upgrade CPU performance with a better price. Please be noted that UCC feature is supported with AM3/AM3+ CPU only, and in addition, not every AM3/AM3+ CPU can support this function because some CPU's hidden core may be malfunctioned.

##### CPU Active Core Control

This allows you to adjust CPU Active Core Control feature. The configuration options depend on the CPU core you adopt. The default value is [Disabled].

---

### **AMD Turbo Core Technology**

This item appears only when the processor you adopt supports this feature. Use this to select enable or disable AMD Turbo Core Technology. Configuration options: [Auto] and [Disabled]. The default value is [Auto].

### **AMD IO C-State Support**

This allows you to enable or disable AMD IO C-State Support. The default value is [Enabled].

### **Processor Maximum Frequency**

It will display Processor Maximum Frequency for reference.

### **North Bridge Maximum Frequency**

It will display North Bridge Maximum Frequency for reference.

### **Processor Maximum Voltage**

It will display Processor Maximum Voltage for reference.

### **Multiplier/Voltage Change**

This item is set to [Auto] by default. If it is set to [Manual], you may adjust the value of Processor Frequency and Processor Voltage. However, it is recommended to keep the default value for system stability.

### **CPU Frequency Multiplier**

For safety and system stability, it is not recommended to adjust the value of this item.

### **CPU Voltage**

It allows you to adjust the value of CPU voltage. However, for safety and system stability, it is not recommended to adjust the value of this item.

### **NB Frequency Multiplier**

For safety and system stability, it is not recommended to adjust the value of this item.

### **CPU NB Voltage**

It allows you to adjust the value of CPU NB voltage. However, for safety and system stability, it is not recommended to adjust the value of this item.

### **HT Bus Speed**

This feature allows you selecting Hyper-Transport bus speed. Configuration options: [Auto], [200MHz] to [2400MHz].

### **HT Bus Width**

This feature allows you selecting Hyper-Transport bus width. Configuration options: [Auto], [8 Bit] and [16 Bit].

### **DRAM Timing Configuration**

#### **DRAM Frequency**

If [Auto] is selected, the motherboard will detect the memory module(s) inserted and assigns appropriate frequency automatically.

---

## DRAM Timing Control



### DRAM Slot

Use this to select DRAM slot to view SPD data. The default value is [DDR3\_A1].

### DRAM Timing Control

Use this to select DRAM control. The default value is [Auto].

### Power Down Enable

Use this item to enable or disable DDR power down mode.

### Bank Interleaving

Interleaving allows memory accesses to be spread out over banks on the same node, or accross nodes, decreasing access contention.

### Channel Interleaving

It allows you to enable Channel Memory Interleaving. Configuration options: [Disabled] and [Auto]. The default value is [Auto].

### Memory Controller Mode

It allows you to adjust the memory controller mode. Configuration options: [Unganged] and [Ganged]. The default value is [Unganged].

---

## **Voltage Configuration**

### **DRAM Voltage**

Use this to select DRAM Voltage. The default value is [Auto].

### **CPU Voltage Offset**

Use this to select CPU Voltage Offset. The default value is [Auto].

### **NB Voltage**

Use this to select NB Voltage. The default value is [Auto].

### **HT Voltage**

Use this to select HT Voltage. The default value is [Auto].

### **CPU VDDA Voltage**

Use this to select CPU VDDA Voltage. The default value is [Auto].

### **PCIE VDDA Voltage**

Use this to select PCIE VDDA Voltage. The default value is [Auto].

### **SB Voltage**

Use this to select SB Voltage. The default value is [Auto].

## **Would you like to save current setting user defaults?**

In this option, you are allowed to load and save three user defaults according to your own requirements.

---

### 3.4 Advanced Screen

In this section, you may set the configurations for the following items: CPU Configuration, North Bridge Configuration, South Bridge Configuration, Storage Configuration, Super IO Configuration, ACPI Configuration, USB Configuration and Network Configuration.



Setting wrong values in this section may cause the system to malfunction.

#### Instant Flash

Instant Flash is a UEFI flash utility embedded in Flash ROM. This convenient UEFI update tool allows you to update system UEFI without entering operating systems first like MS-DOS or Windows®. Just save the new UEFI file to your USB flash drive, floppy disk or hard drive and launch this tool, then you can update your UEFI only in a few clicks without preparing an additional floppy diskette or other complicated flash utility. Please be noted that the USB flash drive or hard drive must use FAT32/16/12 file system. If you execute Instant Flash utility, the utility will show the UEFI files and their respective information. Select the proper UEFI file to update your UEFI, and reboot your system after the UEFI update process is completed.

#### Internet Flash

Internet Flash searches for available UEFI firmware updates from our servers. In other words, the system can auto-detect the latest UEFI from our servers and flash them without entering Windows® OS. Please note that you must be running on a DHCP configured computer in order to enable this function.



---

### 3.4.1 CPU Configuration



#### Cool 'n' Quiet

Use this item to enable or disable AMD's Cool 'n' Quiet™ technology. The default value is [Enabled]. Configuration options: [Enabled] and [Disabled]. If you install Windows® 8 / 7 / Vista™ and want to enable this function, please set this item to [Enabled]. Please note that enabling this function may reduce CPU voltage and memory frequency, and lead to system stability or compatibility issue with some memory modules or power supplies. Please set this item to [Disable] if above issue occurs.

#### Enhance Halt State (C1E)

All processors support the Halt State (C1). The C1 state is supported through the native processor instructions HLT and MWAIT and requires no hardware support from the chipset. In the C1 power state, the processor maintains the context of the system caches.

#### Secure Virtual Machine

When this option is set to [Enabled], a VMM (Virtual Machine Architecture) can utilize the additional hardware capabilities provided by AMD-V. The default value is [Enabled]. Configuration options: [Enabled] and [Disabled].

#### CPU Thermal Throttle

Use this item to enable CPU internal thermal control mechanism to keep the CPU from overheated. The default value is [Auto].

---

## 3.4.2 North Bridge Configuration



### Primary Graphics Adapter

This item will switch the PCI Bus scanning order while searching for video card. It allows you to select the type of Primary VGA in case of multiple video controllers. The default value of this feature is [PCI Express]. Configuration options: [PCI] and [PCI Express].

### IOMMU

Use this to enable or disable IOMMU. The default value of this feature is [Disabled].

---

### 3.4.3 South Bridge Configuration



#### Onboard HD Audio

Select [Auto], [Enabled] or [Disabled] for the onboard HD Audio feature. If you select [Auto], the onboard HD Audio will be disabled when PCI Sound Card is plugged.

#### Front Panel

Select [Auto] or [Disabled] for the onboard HD Audio Front Panel.

#### On/Off Play

Use this item to enable or disable On/Off Play Technology. The default value is [Enabled]. When On/Off Play is enabled, Deep Sx will be disabled. If you want to enable Deep Sx, please disable On/Off Play first.

#### Onboard LAN

This allows you to enable or disable the onboard LAN feature.

#### Good Night LED

Enable this option to turn off Power LED and LAN LED when the system is power on. The keyboard LED will also be turned off in S1, S3 and S4 state. The default value is [Auto].

---

## 3.4.4 Storage Configuration



### SATA Controller

Use this item to enable or disable the “SATA Controller” feature.

### SATA Mode

Use this item to adjust SATA Mode. The default value of this option is [AHCI Mode]. Configuration options: [AHCI Mode], [RAID Mode] and [IDE Mode].



If you set this item to RAID mode, it is suggested to install SATA ODD driver on SATA3\_5 and SATA3\_6 ports.

### AMD AHCI BIOS ROM

Use this item to enable or disable AMD AHCI BIOS ROM. The default value of this option is [Disabled].

### SATA IDE Combined Mode

This item is for SATA3\_5 and SATA3\_6 ports. Use this item to enable or disable SATA IDE combined mode. The default value is [Enabled].



If you want to build RAID on SATA3\_5 and SATA3\_6 ports, please disable this item.

### Aggressive Link Power Management

Use this item to configure Aggressive Link Power Management.

### Hard Disk S.M.A.R.T.

Use this item to enable or disable the S.M.A.R.T. (Self-Monitoring, Analysis, and Reporting Technology) feature. Configuration options: [Disabled], [Auto] and [Enabled].

---

## 3.4.5 Super IO Configuration



### Serial Port

Use this item to enable or disable the onboard serial port.

### Serial Port Address

Use this item to set the address for the onboard serial port. Configuration options: [3F8h / IRQ4] and [3E8h / IRQ4].

### Infrared Port

Use this item to enable or disable the onboard infrared port.

### Infrared Port Address

Use this item to set the address for the onboard infrared port. Configuration options: [2F8 / IRQ3] and [2E8 / IRQ3].

---

## 3.4.6 ACPI Configuration



### Suspend to RAM

Use this item to select whether to auto-detect or disable the Suspend-to-RAM feature. Select [Auto] will enable this feature if the OS supports it.

### Check Ready Bit

Use this item to enable or disable the feature Check Ready Bit.

### ACPI HPET table

Use this item to enable or disable ACPI HPET Table. The default value is [Enabled]. Please set this option to [Enabled] if you plan to use this motherboard to submit Windows® certification.

### Restore on AC/Power Loss

This allows you to set the power state after an unexpected AC/power loss. If [Power Off] is selected, the AC/power remains off when the power recovers. If [Power On] is selected, the AC/power resumes and the system starts to boot up when the power recovers.

### PS/2 Keyboard Power On

Use this item to enable or disable PS/2 keyboard to turn on the system from the power-soft-off mode.

### PCI Devices Power On

Use this item to enable or disable PCI devices to turn on the system from the power-soft-off mode.

### Ring-In Power On

Use this item to enable or disable Ring-In signals to turn on the system from the power-soft-off mode.

### RTC Alarm Power On

Use this item to enable or disable RTC (Real Time Clock) to power on the system.

---

**USB Keyboard/Remote Power On**

Use this item to enable or disable the system to wake from S5 using USB Keyboard/Remote.

**USB Mouse Power On**

Use this item to enable or disable the system to wake from S5 using USB Mouse.

**CSM**

Please disable CSM when you enable Fast Boot option. The default value is [Enabled].

---

## 3.4.7 USB Configuration



### USB 2.0 Controller

Use this item to enable or disable the use of USB 2.0 controller.

### USB 3.0 Controller

Use this item to enable or disable the use of USB 3.0 controller.

### Legacy USB Support

Use this option to select legacy support for USB devices. There are four configuration options: [Enabled], [Auto], [Disabled] and [UEFI Setup Only]. The default value is [Enabled]. Please refer to below descriptions for the details of these four options:

[Enabled] - Enables support for legacy USB.

[Auto] - Enables legacy support if USB devices are connected.

[Disabled] - USB devices are not allowed to use under legacy OS and UEFI setup when [Disabled] is selected. If you have USB compatibility issue, it is recommended to select [Disabled] to enter OS.

[UEFI Setup Only] - USB devices are allowed to use only under UEFI setup and Windows / Linux OS.

### Legacy USB 3.0 Support

Use this option to enable or disable legacy support for USB 3.0 devices. The default value is [Enabled].



---

## 3.4.8 Network Configuration



### Internet Setting

Use this item to set up the internet connection mode. Configuration options: [DHCP (Auto IP)] and [PPPOE].

### UEFI Download Server

Use this item to select UEFI firmware download server for Internet Flash. Configuration options: [Asia], [Europe], [USA] and [China].

---

### 3.5 Hardware Health Event Monitoring Screen

In this section, it allows you to monitor the status of the hardware on your system, including the parameters of the CPU temperature, motherboard temperature, CPU fan speed, chassis fan speed, and the critical voltage.



#### CPU Fan 1 & 2 Setting

This allows you to set the CPU fan 1 & 2 speed. Configuration options: [Full On] and [Automatic Mode]. The default is value [Full On].

#### Chassis Fan 1 Setting

This allows you to set the chassis fan 1 speed. Configuration options: [Full On], [Manual Mode] and [Automatic Mode]. The default is value [Full On].

#### Over Temperature Protection

Use this to enable or disable Over Temperature Protection. The default value is [Enabled].

#### Dehumidifier Function

Users may prevent motherboard damages due to dampness by enabling “Dehumidifier Function”. When enabling Dehumidifier Function, the computer will power on automatically to dehumidify the system after entering S4/S5 state.

#### Dehumidifier Period

This allows users to configure the period of time until the computer powers on and enables “Dehumidifier” after entering S4/S5 state.

#### Dehumidifier Duration

This allows users to configure the duration of the dehumidifying process before it returns to S4/S5 state.

#### Dehumidifier CPU Fan Setting

Use this setting to configure CPU fan speed while “Dehumidifier” is enabled.

---

## 3.6 Boot Screen

In this section, it will display the available devices on your system for you to configure the boot settings and the boot priority.



### Fast Boot

Fast Boot minimizes your computer's boot time. There are three configuration options: [Disabled], [Fast] and [Ultra Fast]. The default value is [Disabled]. Please refer to below descriptions for the details of these three options:

[Disabled] - Disable Fast Boot.

[Fast] - The only restriction is you may not boot by using an USB flash drive.

[Ultra Fast] - There are a few restrictions.

1. Only supports Windows® 8 UEFI operating system.
2. You will not be able to enter BIOS Setup (Clear CMOS or run utility in Windows® to enter BIOS Setup).
3. If you are using an external graphics card, the VBIOS must support UEFI GOP in order to boot.

### Boot From Onboard LAN

Use this item to enable or disable the Boot From Onboard LAN feature.

### Setup Prompt Timeout

This shows the number of seconds to wait for setup activation key. 65535(0xFFFF) means indefinite waiting.

### Bootup Num-Lock

If this item is set to [On], it will automatically activate the Numeric Lock function after boot-up.

---

### **Full Screen Logo**

Use this item to enable or disable OEM Logo. The default value is [Enabled].

### **AddOn ROM Display**

Use this option to adjust AddOn ROM Display. If you enable the option "Full Screen Logo" but you want to see the AddOn ROM information when the system boots, please select [Enabled]. Configuration options: [Enabled] and [Disabled]. The default value is [Enabled].

### **Boot Failure Guard**

Enable or disable the feature of Boot Failure Guard.

### **Boot Failure Guard Count**

Enable or disable the feature of Boot Failure Guard Count.

---

### 3.7 Security Screen

In this section, you may set or change the supervisor/user password for the system. For the user password, you may also clear it.



---

## 3.8 Exit Screen



### Save Changes and Exit

When you select this option, it will pop-out the following message, "Save configuration changes and exit setup?" Select [OK] to save the changes and exit the UEFI SETUP UTILITY.

### Discard Changes and Exit

When you select this option, it will pop-out the following message, "Discard changes and exit setup?" Select [OK] to exit the UEFI SETUP UTILITY without saving any changes.

### Discard Changes

When you select this option, it will pop-out the following message, "Discard changes?" Select [OK] to discard all changes.

### Load UEFI Defaults

Load UEFI default values for all the setup questions. F9 key can be used for this operation.

---

## **4. Software Support**

### **4.1 Install Operating System**

This motherboard supports various Microsoft® Windows® operating systems: 8 / 8 64-bit / 7 / 7 64-bit / Vista™ / Vista™ 64-bit / XP / XP 64-bit. Because motherboard settings and hardware options vary, use the setup procedures in this chapter for general reference only. Refer to your OS documentation for more information.

### **4.2 Support CD Information**

The Support CD that came with the motherboard contains necessary drivers and useful utilities that enhance the motherboard features.

#### **4.2.1 Running The Support CD**

To begin using the support CD, insert the CD into your CD-ROM drive. The CD automatically displays the Main Menu if “AUTORUN” is enabled in your computer. If the Main Menu did not appear automatically, locate and double click on the file “ASSETUP.EXE” from the BIN folder in the Support CD to display the menus.

#### **4.2.2 Drivers Menu**

The Drivers Menu shows the available devices drivers if the system detects the installed devices. Please install the necessary drivers to activate the devices.

#### **4.2.3 Utilities Menu**

The Utilities Menu shows the applications software that the motherboard supports. Click on a specific item then follow the installation wizard to install it.

#### **4.2.4 Contact Information**

If you need to contact ASRock or want to know more about ASRock, welcome to visit ASRock's website at <http://www.asrock.com>; or you may contact your dealer for further information.

---

## **Installing OS on a HDD Larger Than 2TB**

This motherboard is adopting UEFI BIOS that allows Windows® OS to be installed on a large size HDD (>2TB). Please follow below procedure to install the operating system.

1. Please make sure to use **Windows® Vista™ 64-bit (with SP1 or above)**, **Windows® 7 64-bit** or **Windows® 8 64-bit**.
2. Press <F2> or <Delete> at system POST. Set **AHCI Mode** in UEFI Setup Utility > Advanced > Storage Configuration > SATA Mode.
3. Choose the item “**UEFI:xxx**” to boot in UEFI Setup Utility > Boot > Boot Option #1. (“xxx” is the device which contains your Windows® installation files. Normally it is an optical drive.) You can also press <F11> to launch boot menu at system POST and choose the item “**UEFI:xxx**” to boot.
4. Start Windows® installation.



---

## Installing OS on a HDD Larger Than 2TB in RAID Mode

This motherboard is adopting UEFI BIOS that allows Windows® OS to be installed on a large size HDD (>2TB). Please follow below procedure to install the operating system.

1. Please make sure to use **Windows® Vista™ 64-bit (with SP1 or above), Windows® 7 64-bit or Windows® 8 64-bit.**
2. Press <F2> or <Delete> at system POST. Set **RAID Mode** in UEFI Setup Utility > Advanced > Storage Configuration > SATA Mode.
3. Choose **onboard RAID 3TB+ unlocker > UEFI Mode For GPT partition.** Press <F10> to save the change and exit.
4. Press <F11> to enter Boot Manual. Choose **UEFI : Built - in EFI Shell.**



5. Key in **drvcfg**, for example you will see below:  
**Drv[4E] Ctrl[B5] Lang[eng]**

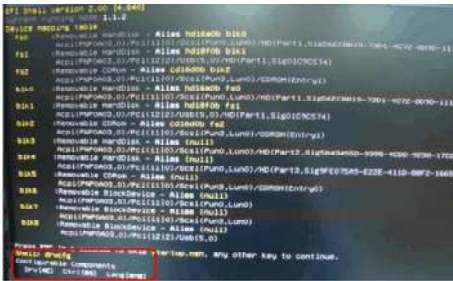

6. Key in **dh [Drv number]**, for example: key in **dh 4E**.

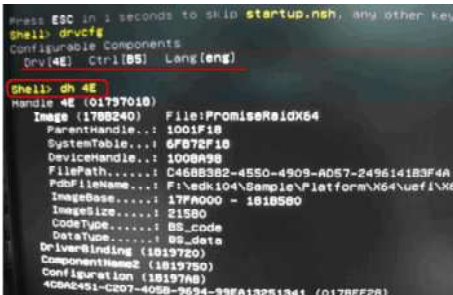

- 
7. And then key in `drvcfg -s [Drv number] [Ctrl number]` to enter Raid Utility.  
For example: key in `drvcfg -s 4E B5`.

```
Press ESC to 4 seconds to skip startup.nsh and other...
Shell> drvcfg
Configurable COMPONENTS
-----
Ctrl B5: Lanx (eng)

Shell> dh 4E
Handle 4E (0179701B)
Proc: 4769240 File: PromiseRaidK64
ParentHandle...: 1001F1B
SystemTable...: 6FB72F1B
MmSystemTable...: 100AA00
FastIoTable...: C468B882-4550-4909-AD57-2496141B3F
PDRFFileName...: F:\edk104\Sample\Platform\X64\uefi\
ImageBase...: 17FA000 - 1818500
ImageSize...: 21500
CodeType...: BS_code
DataCode...: BS_data
DriverBinding: 1919700
ComponentName: 1019750
Configuration: 1019780
XXXXXXXX-0007-405B-9694-99EA13251941 (0178EF28)

Shell> drvcfg -s 4E B5
```

8. Choose **Logical Drive Main Menu** to set up Raid Drive.

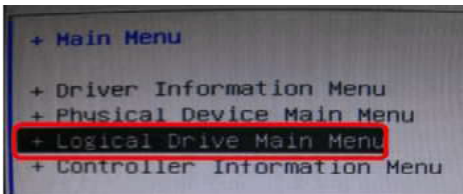

9. Choose **Logical Drive Create Menu** to create a Raid Drive.

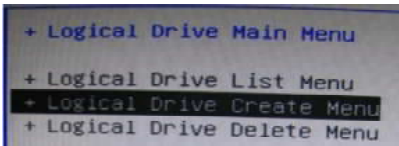

10. Choose **Usable Physical Drive List** to select Raid HDD.

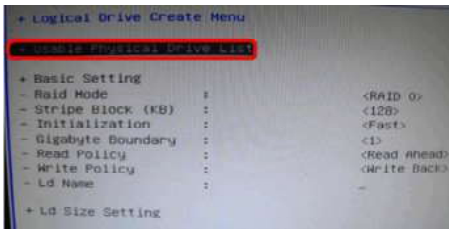

11. Press **Space** on keyboard to toggle checkbox.

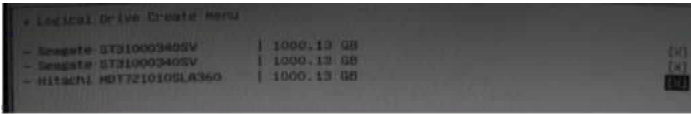

12. Choose **Ld Size** setting, and key in the Raid size.

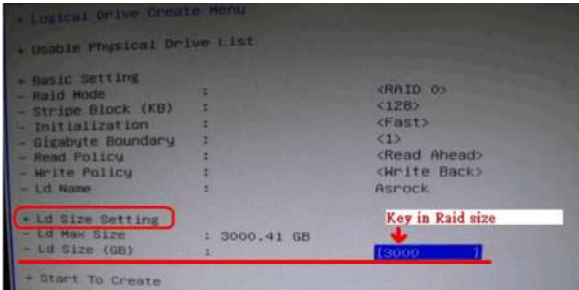

13. After set up Raid size, please click **Start to Create**.

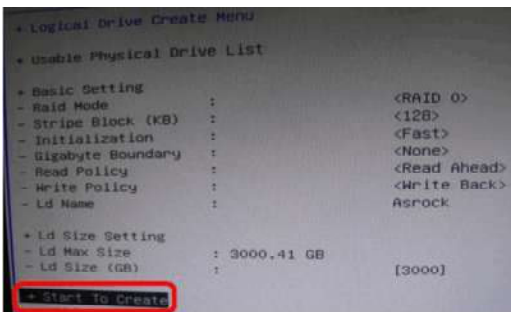

14. Press **<F10>** to exit Utility.

15. During reboot, please press **<F11>** to enter Boot Manual. Choose **UEFI: SCSI CD/DVD Drive**.

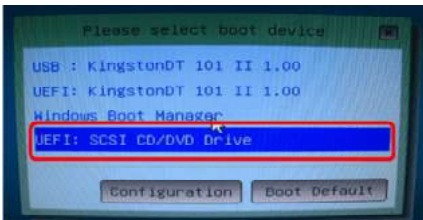

\* This option only shows on Windows® 8 64-bit, 7 64-bit and Vista™ 64-bit OS.

16. Follow Windows® Installation Guide to install OS.

If you install Windows® 8 64-bit / 7 64-bit / Vista™ 64-bit in a large hard disk (ex. Disk volume > 2TB), it may take more time to boot into Windows® or install driver/utilities. If you encounter this problem, you will need to following instructions to fix this problem.

**Windows® Vista™ 64-bit:**

Microsoft® does not provide hotfix for this problem. Below steps are Microsoft® suggested solution:

A. Disable System Restore.

- a. Type “systempropertiesprotection” in the Start Menu. Then press “Enter”.

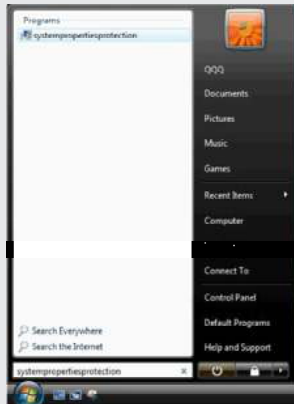

- b. De-select Local Disks for System Restore. Then Click “Turn System Restore Off” to confirm. Then Press “Ok”.



B. Disable “Volume Shadow Copy” service.

a. Type “computer management” in the Start Menu, then press “Enter”.

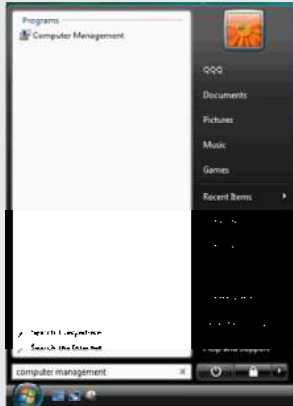

b. Go to “Services and Applications>Services”; Then double click “Volume Shadow Copy”.

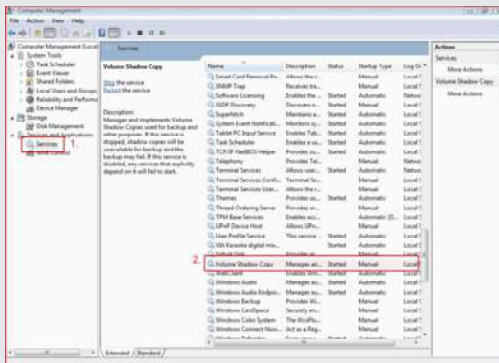

c. Set “Startup type” to “Disable” then Click “OK”.

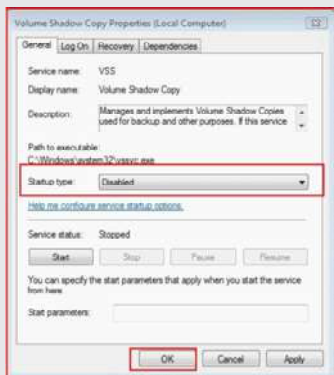

- 
- C. Reboot your system.
  - D. After reboot, please start to install motherboard drivers and utilities.

**Windows® 8 64-bit / 7 64-bit:**

- A. Please request the hotfix KB2505454 thru this link:  
<http://support.microsoft.com/kb/2505454/>
- B. After installing Windows® 8 64-bit / 7 64-bit, install the hotfix kb2505454.  
(This may take long time; >30 mins.)
- C. Reboot your system. (It may take about 5 mins to boot.)
- D. The Windows® will install this hotfix then reboot by itself.
- E. Please start to install motherboard drivers and utilities.

17. Finish.